

# **GLINT** *Gamma2*<sup>®</sup>

REFERENCE GUIDE

**DRAFT ONLY**

**PROPRIETARY AND CONFIDENTIAL  
INFORMATION**





**3D***labs*<sup>®</sup>

**GLINT** *Gamma2*<sup>®</sup>  
*Reference Guide*<sup>™</sup>

**PROPRIETARY AND CONFIDENTIAL  
INFORMATION**

**Issue 1**

---



---

---

## Proprietary Notice

---

---

The material in this document is the intellectual property of **3Dlabs**. It is provided solely for information. You may not reproduce this document in whole or in part by any means.

While every care has been taken in the preparation of this document, **3Dlabs** accepts no liability for any consequences of its use. Our products are under continual improvement and we reserve the right to change their specification without notice. **3Dlabs** may not produce printed versions of each issue of this document. The latest version will be available from the **3Dlabs** web site.

**3Dlabs** products and technology are protected by a number of worldwide patents. Unlicensed use of any information contained herein may infringe one or more of these patents and may violate the appropriate patent laws and conventions.

**3Dlabs** is the worldwide trading name of **3Dlabs** Inc. Ltd.

**3Dlabs**, GLINT Gamma and GLINT are registered trademarks of **3Dlabs** Inc. Ltd.

Microsoft, Windows and Direct3D are either registered trademarks or trademarks of Microsoft Corp. in the United States and/or other countries. OpenGL is a registered trademark of Silicon Graphics, Inc. All other trademarks are acknowledged and recognized.

© Copyright **3Dlabs** Inc. Ltd. 1999. All rights reserved worldwide.

Email: [info@3dlabs.com](mailto:info@3dlabs.com)

Web: <http://www.3dlabs.com>

**3Dlabs** Ltd.

Meadlake Place  
Thorpe Lea Road, Egham  
Surrey, TW20 8HE  
United Kingdom  
Tel: +44 (0) 1784 470555  
Fax: +44 (0) 1784 470699

**3Dlabs** K.K.

Shiroyama JT Mori Bldg 16F  
40301 Toranomom  
Minato-ku, Tokyo, 105, Japan  
Tel: +81-3-5403-4653  
Fax: +91-3-5403-4646

**3Dlabs** Inc.

480 Potrero Avenue  
Sunnyvale, CA 94086,  
United States  
Tel: (408) 530-4700  
Fax: (408) 530-4701

---

---

## Change History

---

---

Document	Issue	Date	Change
149.6.0	1	15 July 99	First Issue.

---

---

## Errata and Alerts

---

---

Refer to Release 4 or later releases of the common Gamma 1 / Gamma 2 Errata and Alerts document.

---



---

## Contents

---

Proprietary Notice .....	1
Change History .....	2
Errata and Alerts.....	2
Contents .....	3
<b>1 INTRODUCTION .....</b>	<b>5</b>
1.1 What is the GLINT Gamma2? .....	5
1.2 The GLINT Family.....	5
<b>2 FUNCTIONAL OVERVIEW .....</b>	<b>6</b>
2.1 Reset Mode Control.....	6
2.1.1 <i>Delta compatible configuration mode</i> .....	8
2.1.2 <i>Serial configuration mode</i> .....	9
2.2 Gamma multi-function support.....	11
2.2.1 <i>PCI Multi-function indication</i> .....	11
2.2.2 <i>PCI 66MHz capable</i> .....	11
2.2.3 <i>Force Legacy Class Codes</i> .....	11
2.3 PCI Address Regions .....	11
2.4 PCI Configuration Space.....	12
2.5 Gamma Control Registers.....	12
2.6 VGA Support .....	12
2.6.1 <i>VGA Aliasing</i> .....	13
2.6.2 <i>VGA decode control</i> .....	13
2.7 VGA register shadowing .....	13
2.8 Multi-GLINT aperture .....	14
<b>3 PCI CONFIGURATION REGION .....</b>	<b>15</b>
3.1 Internal Function Configuration Registers.....	15
3.2 Device Identification.....	17
3.3 Device Control.....	19
3.3.1 <i>Command Register</i> .....	19
3.4 Device Status .....	20
3.4.1 <i>Status Register</i> .....	20
3.5 Miscellaneous Functions .....	21
3.6 AGP Registers.....	26
3.7 Serial EEPROM Access .....	28
3.8 Indirect Region 0 access though configuration space .....	29

3.9	Base Addresses .....	30
3.10	Gamma Functions .....	31
<b>4</b>	<b>REGION 0 - CONTROL REGISTERS.....</b>	<b>34</b>
4.1	Region 0 Address Map.....	34
4.2	Control Status Registers.....	34
4.2.1	Reset Status Register.....	37
4.2.2	DMA Start Address .....	37
4.2.3	Page Table Length Register .....	48
4.2.4	Gamma Processor Mode Register .....	54
4.3	Graphics Core Registers .....	59
4.4	Graphics Core FIFO Interface.....	59
<b>5</b>	<b>ELECTRICAL DATA.....</b>	<b>61</b>
5.1	Absolute Maximum Ratings.....	61
5.2	DC Specifications.....	61
5.3	AC Specifications .....	62
5.1.1	Clock Timing.....	63
5.1.2	Input / Output Timing .....	64
<b>6</b>	<b>PIN INFORMATION .....</b>	<b>67</b>
6.1	Pin Characteristics.....	67
6.1.1	Pinlist by Pin name .....	68
6.1.2	Pin Listing by Ball Coordinates .....	75
<b>7</b>	<b>PACKAGE DIMENSIONS .....</b>	<b>83</b>
<b>8</b>	<b>GAMMA SYSTEM DESIGN .....</b>	<b>85</b>
8.1	Termination / Pull-ups .....	85
8.2	Secondary device IDSel wiring.....	85
8.3	GLINT side-band signals .....	85
8.4	Using a secondary bus master.....	85
<b>9</b>	<b>THERMAL CHARACTERISTICS.....</b>	<b>86</b>
9.1	Device Characteristics.....	86
9.2	Thermal Model.....	86
9.3	Operation Without Heatsink.....	87
9.4	Operation With Heatsink .....	87
9.4.1	Heatsink Attachment .....	87
<b>10</b>	<b>INDEX .....</b>	<b>88</b>



---

---

# 1

## Introduction

---

---

This document has been written as the reference for hardware and system designers who wish to develop hardware or software using the GLINT® Gamma geometry processor. A familiarity with the functionality of the GLINT rendering devices is assumed in this document.

### 1.1 What is the GLINT Gamma2?

GLINT Gamma2 is a lighting and geometry processor, designed to break the 3D lighting and geometry bottleneck on PCs. GLINT Gamma implements the full 3D lighting and geometry pipeline for any 3Dlabs rendering device, e.g. GLINT 500TX, GLINT MX, etc. The lighting and geometry calculations in GLINT Gamma are general purpose and may be used to accelerate any 3D API, including OpenGL, Direct3D and Apple's QuickDraw 3D.

The GLINT Gamma2 contains two on-chip PCI Local Bus interfaces: the primary interface communicates with the host processor and the secondary interface communicates with other PCI devices such as GLINT 500TX, GLINT MX or an SVGA device.

GLINT Gamma functions as a AGP/PCI to PCI multi-function adapter. So, in addition to calculating the geometric information, the GLINT Gamma can act as a bridge between the PCI bus and multiple graphics devices. This capability may be used in various ways:

- Driving twin GLINT 500TX or GLINT MX devices for increased rendering speed;
- Driving a GLINT rendering device plus an SVGA device for 3D acceleration with on-board VGA.

### 1.2 The GLINT Family

The GLINT 500TX and MX graphics processors provide 100% OpenGL compliant rendering combined with state-of-the-art Windows acceleration. VRAM framebuffer support enables the high screen resolutions required by professional applications such as CAD and visualization.

The GLINT Gamma is completely compatible with GLINT 500TX and MX rendering devices providing a glueless hardware interface. The GLINT Gamma programming model is fully compatible with the other GLINT devices.

# 2

## Functional Overview

The GLINT Gamma adds extra 3D graphics acceleration to the 3DLabs' rendering devices by implementing the geometry, lighting, slope and setup calculations for 3D primitives in hardware. The processing required on the host is greatly reduced and much less data is passed from the host to the graphics subsystem.

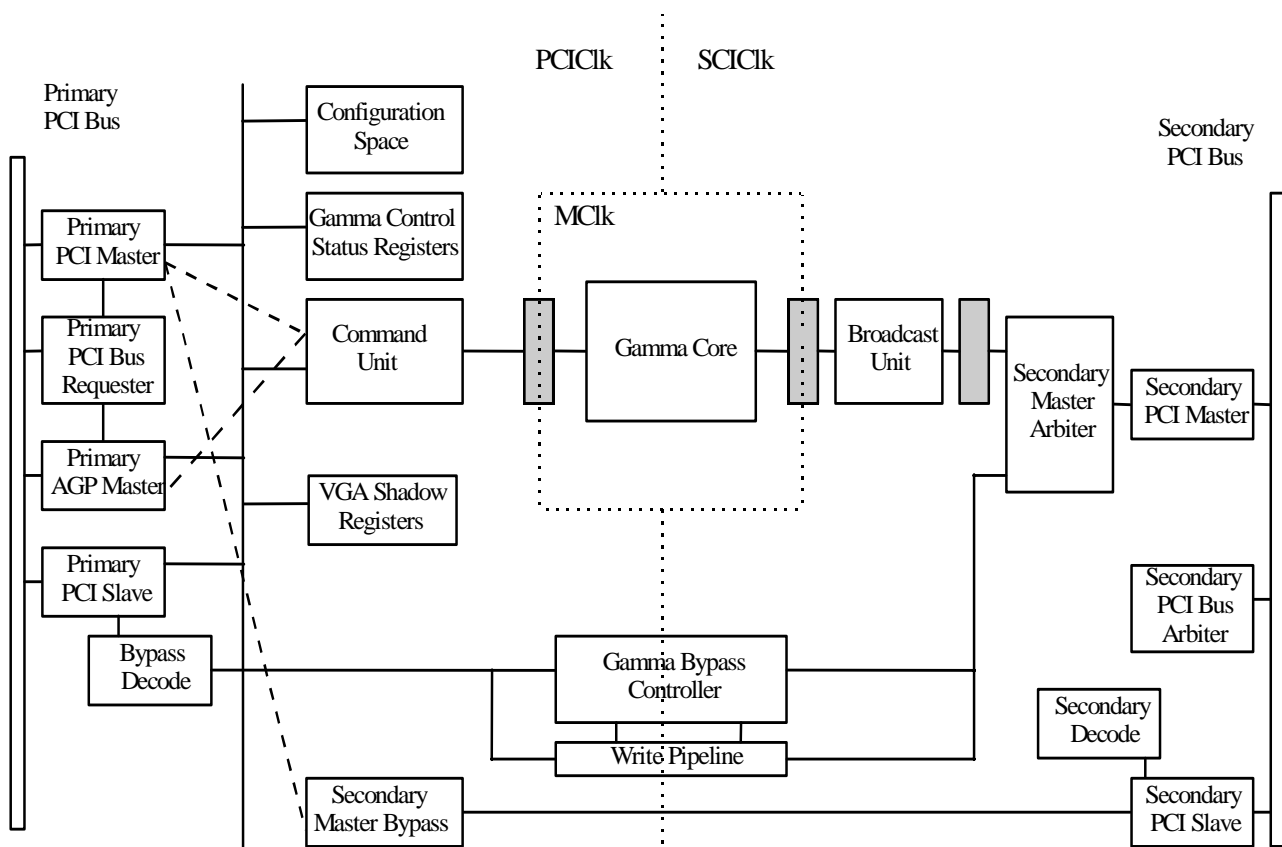

Figure 2-1 Functional Overview

For PCI accesses, if the access is for the Graphics Processor, it is directed towards the Command unit. If it is for a secondary target, the access is directed towards the Gamma Bypass Controller. The bus interface contains a number of PCI Configuration Registers and also various Control Status registers for the Gamma.

### 2.1 Reset Mode Control

A number of the parameters for the bus interface are set at reset time. There are two modes of reset configuration control in Gamma. The first mode is Delta compatible, the

second uses a Serial EEPROM (Serial Mode) to allow greater configuration set-up control. In Delta compatible mode there are some hardwired mode pins. In both modes some of the reset state is configured using resistors connected to configuration pins. These pins normally form part of the Gamma operation, but are tri-state at reset. The state of configuration pins is sampled on the trailing edge of reset.

The resulting reset state is stored as Configuration bits within Gamma.

Configuration Bit	Description
PCI66MHzCapable	1 = 66MHz Capable
AGPCapable	1 = AGP Capable
SBCapable	1 = AGP Sideband Addressing Capable
BaseClassZero	1 = force PCI Base Class Code to be zero
PCIMinGnt[7:6]	top two bits of PCI Minimum Grant register
PCIMaxLat[7:6]	top two bits of PCI Maximum Latency register
ExtDevice1	1 = Enable external device 1
ExtDevice2	1 = Enable external device 2
ExtDevice3	1 = Enable external device 3
ExtVGAMode	0 = No VGA 1 = External device 1 is a VGA device 2 = External device 3 is a VGA device 3 = No VGA
VGANonAlias	See 2.6 VGA Support for definitions of the VGANonAlias
VGAControl	See 2.6 VGA Support for definitions of the VGA control bits
GlintEn1	1 = External Device 1 is a GLINT device 0 = External Device 1 is any other device
GlintEn2	1 = External Device 2 is a GLINT device 0 = External Device 2 is any other device
MultiGLINTAp	Multi GLINT aperture size control: if GlintEn1 = 1 and GlintEn2 = 1 then 00 = 0M     DISABLED 01 = 16M 10 = 32M 11 = 64M else DISABLED
SubsystemVendorID[15:0]	Subsystem Vendor ID
SubsystemID[15:0]	Subsystem ID

**Table 2-1 Gamma Configuration Bit Definitions**

### 2.1.1 Delta compatible configuration mode

Delta compatible configuration mode is provided to allow a Gamma chip to be placed directly onto current Delta boards without any hardware changes. All new designs should use the Gamma serial configuration mode.

In Delta compatible mode, the configuration bits are loaded from mode and configuration pins, in exactly the same way as Delta. Some configuration bits are hard-coded and cannot be used in this mode of operation. To switch to Serial configuration mode the ExtFunc pins are set to 00b. This setting would never be used on any current Delta board design, so making the new mode backwards compatible with current Delta boards.

The configuration pins are listed in the tables below:

Mode Pin	Description	Mode
ExtFunc[1:0]	00b	Serial Configuration
	01b ExtDevice1 = 1 ExtDevice2 = 0 ExtDevice3 = 0	Delta Compatible
	10b ExtDevice1 = 0 ExtDevice2 = 1 ExtDevice3 = 0	Delta Compatible
	11b ExtDevice1 = 1 ExtDevice2 = 1 ExtDevice3 = 0	Delta Compatible

**Table 2-2 External Function Enable Pins (Mode control for Gamma)**

Mode Pin	Description
AGPSBA[0] (was ModeCtl[0])	1 = Report legacy PCI Base class BaseClassZero = 1b 0 = Report PCI 2.1 Base class BaseClassZero = 0b
AGPSBA[1] (was ModeCtl[1])	1 = PCIMaxLat[7:6] = 00b PCIMinGnt[7:6] = 11b 0 = PCIMaxLat[7:6] = 11b PCIMinGnt[7:6] = 11b
VGAEnable	1= External Device 1 is VGA device ExtVGAMode = 01b 0 = No VGA present ExtVGAMode = 00b Note: Delta compatibility mode only supports External Device 1 as VGA

**Table 2-3 Delta compatible Mode Pins**

Configuration Pin	Description
GLINTInDis[0]	Target device 0 GLINT control Pull low (4K7) if GLINT GlintEn1 = 1 else Pull High (4K7) GlintEn1 = 0
GLINTInDis[1]	Target device 1 GLINT control Pull low (4K7) if GLINT GlintEn2 = 1 else Pull High (4K7) GlintEn2 = 0

**Table 2-4 Delta compatible Configuration Pins**

Configuration Bits	Value	Note
PCI66MHzCapable	0b	
AGPCapable	0b	
SBACapable	0b	
VGANonAlias	0b	
VGAControl	0000b	
SubsystemVendorID[15:0]	0000h	1
SubsystemID[15:0]	0000h	1

**Table 2-5 Delta compatible Hard coded configuration bits.**

*Note 1: In Delta compatible mode the subsystem registers are Write-once, reset to 0000h.*

### 2.1.2 Serial configuration mode

In serial configuration mode the Gamma configuration bits are set from configuration pins, and from a serial EEPROM. The EEPROM chosen for use with Gamma is the Xicor X84041-3 or X84041-2.7. For more information on this part please refer to the Xicor data sheet. Other serial EEPROMs may be usable if they are 100% compatible with the Xicor part.

Pin	Description
SerialCEN	Serial EEPROM Chip Enable
SerialOEN	Serial EEPROM Output Enable
SerialWEN	Serial EEPROM Write Enable
SerialData	Serial EEPROM Data bit

**Table 2-6 Serial Mode Operation: EEPROM Pins**

Configuration Pin	Description
SerialData	Pull High (4k7) if external VGA target present else Pull Low (4k7)
SerialOEN:SerialWEN	Secondary PCI Bus Clock Control Set using 4k7 Pull-ups and pull-downs for following codes. 00b = SCIClk[0:3] = PCIClk 01b = SCIClk[0:3] = PCIClk 10b = SCIClk[0:3] = PCIClk/2 11b = SCIClk[0:3] = PCIClk/2
VGAEnable	In serial mode this pin is used to set the value of the 66MHz capable bit in the Configuration Status register. 0b = 66MHz capable bit not set 1b = 66MHz capable bit set

Table 2-7 Serial Mode Operation: Configuration Pins

EEPROM Data Bit	Configuration Bits
0	AGPCapable
1	SBACapable
2	BaseClassZero
[4:3]	PCIMinGnt[7:6]
[6:5]	PCIMaxLat[7:6]
7	ExtDevice1
8	ExtDevice2
9	ExtDevice3
[11:10]	ExtVGAMode
12	VGANonAlias
[16:13]	VGAControl
17	GlintEn1
18	GlintEn2
[20:19]	MultiGLINTAp[1:0]
[47:32]	SubsystemVendorID[15:0]
[63:48]	SubsystemID[15:0]

Table 2-8 Serial Mode Operation: EEPROM Bit Definitions

*Note* The ExtVGAMode bits are qualified by the configuration state on the SerialData pin. If the hardware configuration is set such that VGA target is defined to be absent, the EEPROM bits will be ignored, and ExtVGAMode will be set to 00b.

Bits 0 to 20 of the Gamma configuration are visible in the **ChipConfig** register. This register can be read back over the PCI bus. Some of the bits

are writable and may be modified by the host processor if required — see **ChipConfig** register specification in this document. The **PCI66MHzCapable**, and **subsystem Vendor ID**, and **subsystem ID** are visible only in the appropriate PCI configuration register.

## 2.2 Gamma multi-function support

The GLINT Gamma includes circuitry to allow multiple single function PCI devices attached to its secondary bus to look like a single PCI multi-function device. To achieve this the Gamma device adjusts the results of certain secondary device configuration space accesses.

### 2.2.1 PCI Multi-function indication

To indicate a multi-function device all functions must return Bit 7 of the Header Type register set to a ‘1’. This bit is set by Gamma during a read of a secondary device Header Type register.

### 2.2.2 PCI 66MHz capable

To indicate 66MHz capability all functions must return Bit 5 of the Header Type register set to a ‘1’. This bit is set by Gamma during a read of a secondary device Status register if the Gamma **PCI66MHzCapable** configuration bit is set.

### 2.2.3 Force Legacy Class Codes

If **BaseClassZero** is set, GLINT Gamma will override the PCI base and sub class reported by devices on the secondary PCI bus. GLINT Gamma and any GLINT rendering device on the secondary PCI bus will have 00h reported as their PCI base class and 00h reported as their PCI sub-class. Any VGA device on the secondary PCI bus will have 00h reported as its PCI base class and 01h reported as its PCI sub-class.

## 2.3 PCI Address Regions

The Gamma PCI interface implements four PCI Address Regions, shown in Table 2-2.

The standard VGA-compatible Memory and I/O Space addresses are decoded when the Gamma has been suitably configured. These addresses do not form a single contiguous region, but are mentioned in the table for completeness.

Region	Address Space	Bytes	Description	Comments
Config	Configuration	256	PCI Configuration	PCI special
Zero	Memory	128K	Control Registers	relocatable
Two	Memory	Note 1.	Multi-GLINT aperture	relocatable
ROM	Memory	0K	Expansion ROM	No ROM
VGA	Memory & I/O	—	VGA Addresses	Note 2.

**Table 2-9 Gamma PCI Address Regions.**

*Note 1: Multi-GLINT aperture size is variable. Size is set by EEPROM configuration bits at reset.*

*Note 2: VGA Addresses are decoded by Gamma when then VGA Present configuration bit is set to be processed by VGA chip on the secondary Bus.*

## 2.4 PCI Configuration Space

The PCI Configuration Space provides a set of 'hooks' which satisfies the needs of current and anticipated system configuration mechanisms. The configuration registers are accessed and modified by the use of PCI Configuration Read and Write commands, and will normally be initialized by BIOS or similar low-level code at system power-up and reset.

Sixty four bytes of the Configuration Registers are predefined within the PCI Specification and are supported by the Gamma. These are defined in Section 28.2 of this document, and are all implemented within the PCI Bus Interface. Registers are provided for device identification, PCI control and status, and as base address registers for the relocatable memory regions. Registers are also provided to allow the reading and writing of the Gamma configuration serial EEPROM.

## 2.5 Gamma Control Registers

The Gamma Region Zero is a 128KByte region containing the control registers, and ports to and from the graphics processor. The control space is mapped in twice within the 128KByte region. In Delta compatible mode the second 64K the registers are mapped to be byte swapped for big endian hosts. For Dual GLINT systems when in Serial mode, Region zero can be configured to allow both GLINT control regions to be visible, the second GLINT being in the second 64K of this region.

A number of Control Status Registers are implemented within the PCI Bus Interface, including registers for interrupt and error handling, reporting graphics processor input FIFO status, and DMA control. All other registers on the Target GLINT are visible through the Gamma Control register space to allow for minimum software changes in supporting a Gamma Device.

## 2.6 VGA Support

The bus interface can be configured to respond to the standard VGA-compatible Memory and I/O Space addresses configuring ExtVGAMode. The interface will then respond to Memory addresses A0000h through BFFFFh.

Gamma can be configured to allow accesses to a number of I/O addresses to allow different types of VGA device to be used on the secondary bus.



### 2.6.1 VGA Aliasing

Aliases of the VGA I/O addresses will be decoded as defined below:

Decode Type	Address operation	VGANonAlias	VGAControl
10 Bit aliasing	Bits 31-10 are ignored	0b	0b
partial aliasing	Bits 31-16 must be 0000h Bits 15-10 are ignored	0b	1b
Full decode	Bits 31-10 must be 000000h	1b	xb

**Table 2-10 VGA Address Aliasing**

### 2.6.2 VGA decode control

The VGA address ranges to be decoded can be configured in Serial mode, as set out in the table below:

I/O Address range	Type	Configuration Control
3B0h - 3BBh, 3C0h - 3DFh	VGA	VGAControl(0) 1 = disabled 0 = enabled
2E8h, 2EAh - 2EFh	XGA	VGAControl(1) 1 = disabled 0 = enabled
102h	Special	VGAControl(2) 1 = disabled 0 = enabled

**Table 2-11 VGA Address Regions**

In Delta compatible mode **VGAControl(3-0)** is set to 0h and **VGANonAlias** to set to 0b. This enables the decoding of all the I/O address ranges with full 10 bit address aliasing to make Gamma fully compatible with Delta in this mode.

### 2.7 VGA register shadowing

The GLINT Gamma shadows a number of the VGA I/O control registers to allow it to work transparently in all systems. These shadow registers ensure that Gamma only responds to the correct VGA memory addresses, and I/O addresses for the current VGA set-up.

This shadowing allows a Gamma to co-exist with a monochrome adapter which is something that was not possible with a GLINT Delta.

## 2.8 Multi-GLINT aperture

The Gamma Multi-GLINT aperture supports two GLINTS with non-shared framebuffers. Addresses into the aperture consist of a Y and an X component. To simplify calculations the X Span into the aperture is always a power of 2. The size of the Gamma aperture is set at reset.

The Aperture Address generator multiplies the Y address by the GLINT X span and then adds the result to the X address.

GLINT X spans supported are 320, 512, 640, 800, 1024, 1152, 1280, 1600, 1920 in 8 bits, 16 bits and 32 bits per pixel.

The address generator can handle GLINT framebuffer aperture sizes of 4M, 8M, 16M, and 32 Mbytes.

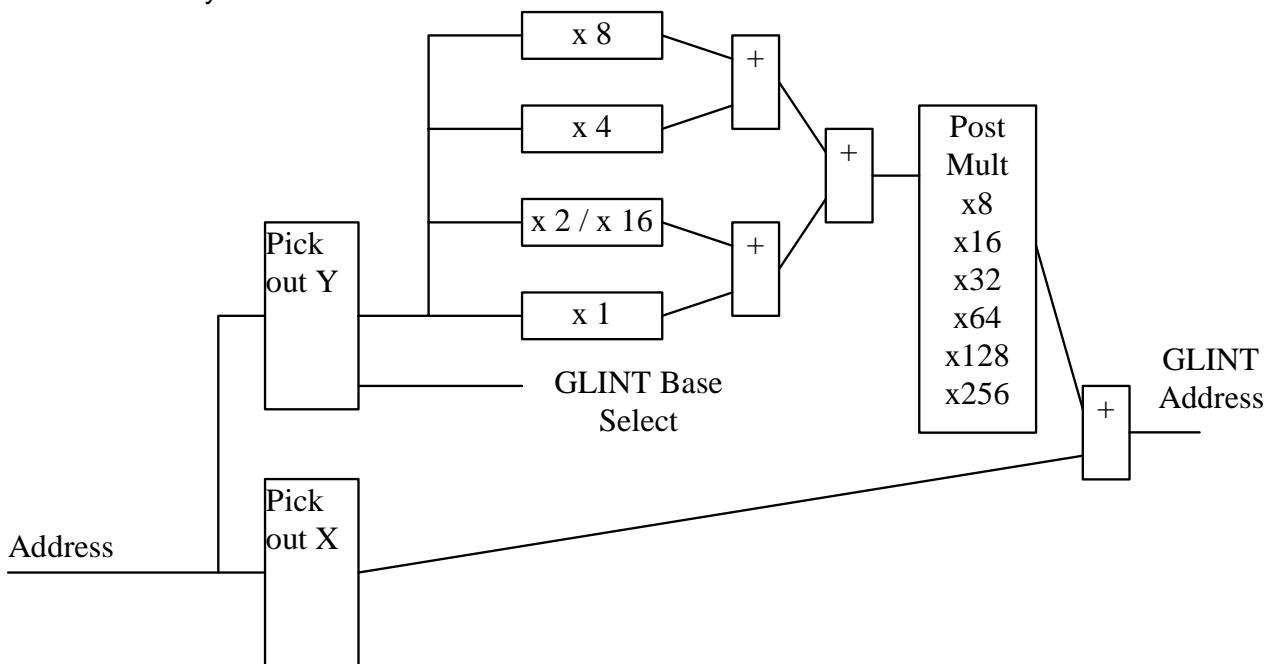

**Figure 2-2 Address generation circuitry**

*Note: The Y address used in forming the GLINT address is 1/2 of the Input Y address, and the bottom bit of the Input Y address is used to select which GLINT Base address to use in the framebuffer access.*

---

---

# 3

## PCI Configuration Region

---

---

The PCI Configuration Region provides a set of 'hooks' which satisfies the needs of current and anticipated system configuration mechanisms. The configuration registers are accessed and modified by the use of Configuration Read and Write commands.

As GLINT Gamma is a multi-function device, the configuration space is split into eight 256 bytes blocks. GLINT Gamma has one internal function and up to 3 external functions.

GLINT Gamma will only respond to configuration space accesses for which devices exist. In Delta mode, hardware mode pins are used to indicate which of the external functions are populated in the system.

### 3.1 Internal Function Configuration Registers

64 bytes of the Configuration registers are predefined within the PCI Specification and are supported by GLINT Gamma. The remaining 192 Bytes are device specific AGP capabilities are configured in a number of registers in this device specific area. All other registers are unused by GLINT Gamma, returning the value zero.

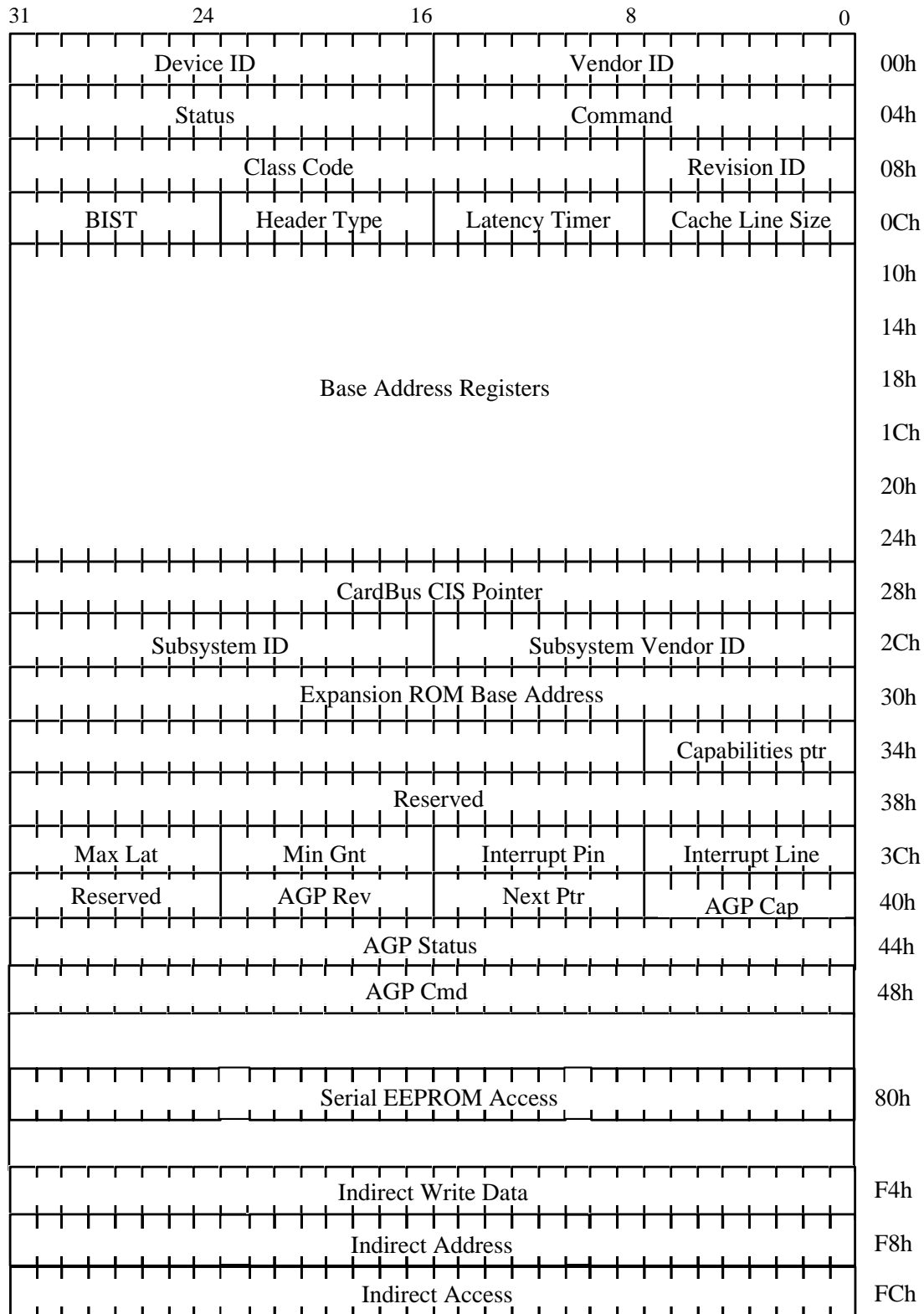

Figure 3-1 Configuration Region.

## 3.2 Device Identification

### CFGVendorID

Name	Type	Offset	Format
CFGVendorID	Config	0x00	Bitfield

*Command register*

Bits	Name	Read	Write	Reset	Description
0...15	Vendor ID	✓	✗	0x000E	3Dlabs company code

---

Notes: Vendor Identification numbers

---

### CFGDeviceID

Name	Type	Offset	Format
CFGDeviceID	Config	0x0002	Bitfield

*Command register*

Bits	Name	Read	Write	Reset	Description
16...31	Device ID	✓	✗	0x0008	GLINT Gamma Device number

---

Notes: Device Identification number

---

### CFGRevisionID

Name	Type	Offset	Format
CFGRevisionID	Config	0x08	Bitfield

*Command register*

Bits	Name	Read	Write	Reset	Description
0...7	Revision ID	✓	✗	Rev. no.	GLINT Gamma Device number

---

Notes: Revision identification number. The revision ID register returns the following code:  
01h = Revision R01

---

## CFGClassCode

Name	Type	Offset	Format
CFGRevisionID	Config	0x09	Bitfield

*Command register*

Bits	Name	Read	Write	Reset	Description
8...15	Device class	✓	✗	0x0B4000	At offset 0x00
16...23	Sub class	✓	✗	0x0B4000	PCI Definition: Co-Processor (unknown type) at offset 0x40
24...31	Base class	✓	✗	0x0B4000	PCI Definition: Processor at offset 0x0B

---

Notes: Class Code Register Revision identification number. The revision ID register returns the following code: 01h = Revision R01

---

## CFGHeaderType

Name	Type	Offset	Format
CFGHeaderType	Config	0x0e	Bitfield

*Command register*

Bits	Name	Read	Write	Reset	Description
16...23	HeaderType	✓	✗	0x80	Header Type. PCI Definition: Multi- function device

---

Notes:

---

### 3.3 Device Control

#### 3.3.1 Command Register

The command register controls the ability of a device to generate and respond to PCI cycles. Writing zero to this register disconnects the device from the PCI for all except configuration accesses. All necessary bits within the command register are supported for the functionality contained in GLINT Gamma.

### CFGCommand

Name	Type	Offset	Format
CFGCommand	Config <i>Command register</i>	0x04	Bitfield

Bits	Name	Read	Write	Reset	Description
0	I/O access enable	✓	✗	0x0000	0 = GLINT Gamma has no I/O space regions
1	Memory access enable	✓	✓	0x0000	0 = Disable memory space accesses. (RESET) 1 = Enable memory space accesses
2	Master enable	✓	✓	0x0000	0 = Disable master accesses. (RESET) 1 = Enable master accesses
3	Special Cycle access enable	✓	✗	0x0000	0 = GLINT Gamma has no I/O space regions
4	Memory Write and Invalidate enable	✓	✗	0x0000	0 = GLINT Gamma master never issues Memory Write and Invalidate accesses.
5	VGA palette snoop enable	✓	✗	0x0000	0 = GLINT Gamma is not a VGA device
6	Parity error report enable	✓	✗	0x0000	0 = GLINT Gamma does not report parity errors.
7	Address/Data stepping enable	✓	✗	0x0000	0 = GLINT Gamma does not do stepping.
8	SERR driver enable	✓	✗	0x0000	0 = GLINT Gamma does not report parity errors.
9	Master Fast back-to-back enable	✓	✗	0x0000	0 = The GLINT Gamma master does not implement fast back-to-back accesses.
10...15	Reserved	✗	✗	0x0000	000000b

## 3.4 Device Status

### 3.4.1 Status Register

The Status Register is used to record status information for PCI related events. The definition for each bit is given below.

Reads to this register behave normally. Writes function differently in that bits can be reset but not set. A bit is reset whenever the register is written and the data in the corresponding bit location is a 1.

### CFGStatus

Name	Type	Offset	Format
CFGStatus	Config <i>Command register</i>	0x06	Bitfield

Bits	Name	Read	Write	Reset	Description
16...19	Reserved	✓	✗	0x00	0.0000b
20	Cap_List	✓	✗		Configured by <b>AGPCapable</b> . 0 = no additional capabilities over PCI2.1 1 = AGP Capability
21	66 MHz Capable	✓	✗		Configured by 66MHz capable configuration pin 0 = Gamma is 33 MHz capable only. 1 = Gamma is 66 MHz capable ( in an AGP system)
22	UDF Supported	✓	✗		0 = Gamma does not support user-definable configurations.
23	Fast Back-to-Back Capable	✓	✗		1 = Gamma can accept fast back-to-back PCI transactions.
24	Data Parity Error Detected	✓	✗		0 = Parity checking not implemented on the Gamma.
25-26	DEVSEL Timing	✓	✗		01b = The Gamma asserts DEVSEL# at medium speed.
27	Signaled Target Abort	✓	✗		0 = The Gamma never signals Target-Abort.
28	Received Target Abort	✓	✗		This bit is set by the Gamma bus master whenever its transaction is terminated with Target-Abort.
29	Received Master Abort	✓	✗		This bit is set by the Gamma bus master whenever its transaction is terminated with Master-Abort.
30	Signaled System Error	✓	✗		0 = The Gamma never asserts a system error.
31	Detected Parity Error	✓	✗		0 = Parity checking is not implemented by the Gamma.



## 3.5 Miscellaneous Functions

### CFGBist

Name	Type	Offset	Format
CFGStatus	Config	0x0f	Bitfield

*Command register*

Bits	Name	Read	Write	Reset	Description
24...31	BIST	✓	✗	0x00	BIST unsupported by GLINT Gamma over the PCI interface.

---

Notes: Optional register used for control and status of BIST (built-in self-test).

---

### CFGLatTimer

Name	Type	Offset	Format
CFGLatTimer	Config	0x0d	Bitfield

*Command register*

Bits	Name	Read	Write	Reset	Description
8...15	Latency Timer Count	✓	✗	0x00	Sets the maximum number of PCI clock cycles for master burst accesses.

---

Notes: This register specifies, in PCI bus clocks, the value of the Latency Timer for this PCI bus master.

---

### CFGCacheLine

Name	Type	Offset	Format
CFGCacheLine	Config	0x0c	Bitfield

*Command register*

Bits	Name	Read	Write	Reset	Description
0...7	Cache Line Size	✓	✗	0x00	Cache line size unsupported.

---

Notes: This register specifies the cache line size in units of 32 bit words. It is only implemented for masters which use the 'Memory write and invalidate' command. GLINT Gamma does not use this command.

---

## CFGMaxLat

<b>Name</b>	<b>Type</b>	<b>Offset</b>	<b>Format</b>
CFGMaxLat	Config	0x3f	Bitfield
	<i>Command register</i>		

Bits	Name	Read	Write	Reset	Description
0...5	Maximum Latency	✓	✗	0x80	00.0000b
6	Maximum Latency[6]	✓	✗		Set by the bit PCIMaxLat[0]
7	Maximum Latency[7]	✓	✗		Set by the bit PCIMaxLat[1]

Notes: This register specifies how often the PCI device needs to gain access to the PCI bus. Two EEPROM bits are used to set the top two bits of this register, and the lower bits are always zero. (Possible register values are thus limited to 00h, 40h, 80h, and C0h.)

## CFGMinGrant

<b>Name</b>	<b>Type</b>	<b>Offset</b>	<b>Format</b>
CFGMinGrant	Config	0x3e	Bitfield
	<i>Command register</i>		

Bits	Name	Read	Write	Reset	Description
0...5	Maximum Grant[5:0]	✓	✗	configured	00.0000b
6	Minimum Grant[6]				Set by the bit PCIMinGnt[0]
7	Minimum Grant[7]				Set by the bit PCIMinGnt[1]

Notes: This register specifies how long a burst period the PCI device needs. Two EEPROM bits are used to set the top two bits of this register, and the lower bits are always zero. (Possible register values are thus limited to 00h, 40h, 80h, and C0h.)

## CFGIntPin

Name	Type	Offset	Format
CFGIntPin	Config	0x3d	Bitfield
<i>Command register</i>			

Bits	Name	Read	Write	Reset	Description
0...7	IntPin	✓	✗	0x01	01h GLINT Gamma uses Interrupt pin A

---

Notes: The Interrupt Pin register tells the BIOS which interrupt line GLINT Gamma uses

---

## CFGIntLine

Name	Type	Offset	Format
CFGIntLine	Config	0x3c	Bitfield
<i>Command register</i>			

Bits	Name	Read	Write	Reset	Description
0...7	IntLine	✓	✗	0x00	01h GLINT Gamma uses Interrupt pin A

---

Notes: The Interrupt Line register is an 8 bit register used to communicate interrupt line routing information.

---

## CFGCardBus

Name	Type	Offset	Format
CFGCardBus	Config	0x28	Bitfield
<i>Command register</i>			

Bits	Name	Read	Write	Reset	Description
0...31	CardBus pointer	✓	✗	0000.0000h	0000.0000h = Not implemented

---

Notes:

---

## CFGSubsystemVendorId

Name	Type	Offset	Format
CFGSubsystemVendorId	Config	0x3c	Bitfield

*Command register*

Bits	Name	Read	Write	Reset	Description
0...15	Subsystem Vendor ID	✓	✓	configured	

Notes: This register identifies the vendor of the add-in board on which the Gamma device resides. In Delta Compatible reset mode it has a reset value of zero, and can only be written to once; all subsequent writes are discarded. Both bytes of this register should be initialized by the Gamma BIOS after a reset (write once). In Serial Mode the Subsystem ID is read only and is loaded from the Serial EEPROM.

## CFGSubsystemId

Name	Type	Offset	Format
CFGSubsystemId	Config	0x2e	Bitfield

*Command register*

Bits	Name	Read	Write	Reset	Description
16...31	Subsystem ID	✓	✓	configured	

Notes: This register is used to identify the add-in board on which the Gamma device resides. In Delta Compatible reset mode it has a reset value of zero, and can only be written to once; all subsequent writes are discarded. Both bytes of this register should be initialized by the Gamma BIOS after a reset (write once). In Serial Mode the Subsystem ID is read only and is loaded from the Serial EEPROM.

## CFGCapPtr

<b>Name</b>	<b>Type</b>	<b>Offset</b>	<b>Format</b>
CFGCapPtr	Config	0x2e	Bitfield

*Command register*

Bits	Name	Read	Write	Reset	Description
0...7	Capability Ptr	✓	✓	configured	Configured by AGPCapable 00h. when AGPCapable = 0 40h when AGPCapable = 1

---

Notes: The Capabilities Pointer register is an eight bit register used to provide an offset into the configuration space for the first item in a capabilities list. It is used by the Gamma device in an AGP system to point to the AGP capability registers.

---

## 3.6 AGP Registers

### CFGCapID

Name	Type	Offset	Format
CFGCapID	Config	0x40	Bitfield

*Command register*

Bits	Name	Read	Write	Reset	Description
0...7	Capability ID	✓	✗	configured	Configured by AGPCapable 0x00. when AGPCapable = 0 0x02 when AGPCapable = 1

---

Notes: This register specifies that the device has AGP capability

---

### CFGNextPtr

Name	Type	Offset	Format
CFGNextPtr	Config	0x41	Bitfield

*Command register*

Bits	Name	Read	Write	Reset	Description
08...15	Next Ptr	✓	✗	0x00	00h = no further capabilities in list

---

Notes: This register specifies that the device has no next capability item.

---

## CFGAGPRev

Name	Type	Offset	Format
CFGAGPRev	Config	0x42	Bitfield

*Command register*

Bits	Name	Read	Write	Reset	Description
16...19	Minor Rev	✓	✗	configured	Configured by AGPCapable 0h if AGPCapable = 0 0h if AGPCapable = 1
20...23	Major Rev	✓	✗	configured	Configured at reset by AGPCapable 00h if AGPCapable = 0 01h if AGPCapable = 1

---

Notes: This register specifies the revision of the AGP spec the device conforms to

---

## CFGAGPStatus

Name	Type	Offset	Format
CFGAGPStatus	Config	0x44	Bitfield

*Command register*

Bits	Name	Read	Write	Reset	Description
0...1	Rate	✓	✗	configured	Configured by AGPCapable 0h if AGPCapable = 0 1h if AGPCapable = 1
2...8	Reserved	✗	✗		
9	SBA				Configured by AGPCapable and SBACapable 0 if AGPCapable = 0 or SBACapable = 1 1 if AGPCapable = 1 and SBACapable = 1
10...23	Reserved				
24...31	RQ				Maximum number of AGP requests supported Configured by AGPCapable 00h if AGPCapable = 0 1Fh if AGPCapable = 1

---

Notes: This register describes the AGP capabilities of the device.

---

## CFGAGPCCommand

Name	Type	Offset	Format
CFGAGPCCommand	Config	0x48	Bitfield

*Command register*

Bits	Name	Read	Write	Reset	Description
0...1	DataRate	✓	✓	0x00000000	
2...7	Reserved	✗	✗		
8	AGPEnable	✓	✓		0 = AGP Mastering Disabled 1 = AGP Mastering Enabled
9	SBAEnable	✓	✓		0 = sideband Addressing Disabled 1 = sideband Addressing Enabled
10...23	Reserved	✗	✗		
24...31	RQDepth	✓	✓		Maximum number of AGP requests which can be queued

---

Notes:

---

### 3.7 Serial EEPROM Access

## CFGAGPCCommand

Name	Type	Offset	Format
CFGAGPCCommand	Config	0x48	Bitfield

*Command register*

Bits	Name	Read	Write	Reset	Description
0...1	DataRate	✓	✓	0x00000000	
2...7	Reserved	✗	✗		
8	AGPEnable	✓	✓		0 = AGP Mastering Disabled 1 = AGP Mastering Enabled
9	SBAEnable	✓	✓		0 = sideband Addressing Disabled 1 = sideband Addressing Enabled
10...23	Reserved	✗	✗		
24...31	RQDepth	✓	✓		Maximum number of AGP requests which can be queued

---

Notes:

---



## CFGSerialEnable

Name	Type	Offset	Format
CFGSerialEnable	Config	0x80	Bitfield

*Command register*

Bits	Name	Read	Write	Reset	Description
0.	Serial EEPROM Data Pin	✓	✓	0x00000000	
1...31	Reserved	✗	✗		

---

Notes: This register is used to access the Configuration Serial EEPROM. Reads and writes of the EEPROM can be initiated by setting up the correct stream of read and write accesses to the bottom bit of this register. For details of the read / write patterns to be used, see the XICOR data sheet on the X84041 operation. Note the EEPROM is also programmable and readable through a region 0 register.

---

### 3.8 Indirect Region 0 access though configuration space

Three configuration registers are provided to allow indirect accesses to region 0 through configuration space accesses. The offset to the region that is to be accessed is loaded into the Indirect Address register. For a write access, the data to be written is loaded into the Indirect Write Data register. The write access is then initiated by writing to the Indirect Access register. The data value written into the Indirect Access register is ignored. For a read access a read of the Indirect Access register returns the values at the current Indirect Address offset.

## CFGIndirectWriteData

Name	Type	Offset	Format
CFGIndirectWriteData	Config	0xf4	Bitfield

*Command register*

Bits	Name	Read	Write	Reset	Description
0...31	Indirect write data	✓	✓	0x00000000	

---

Notes: The Indirect Write Data register holds data value which will be written with Indirect write access.

---

## CFGIndirectAddress

Name	Type	Offset	Format
CFGIndirectAddress	Config	0xf8	Bitfield

*Command register*

Bits	Name	Read	Write	Reset	Description
0...22	IndirectAddress	✓	✓	0x00000000	Address offset within region
23...27	Reserved	✗	✗		
28...31	Base Address select				0 = Base Address 0 1 to 7 = Reserved

Notes:

## CFGIndirectAccess

Name	Type	Offset	Format
CFGIndirectAccess	Config	0xfc	Bitfield

*Command register*

Bits	Name	Read	Write	Reset	Description
0...31	Indirect Data	✓	✓	0x00000000	Writes: Data value ignored Reads: Indirect access read data value

Notes: Accessing the Indirect access register initiates the indirect region 0 access

## 3.9 Base Addresses

The base address registers allow the boot software to relocate PCI devices in the address spaces. At system power-up device independent software must be able to determine which devices are present, build a consistent address map, and determine if a device has an expansion ROM. All undefined Base address registers are read only and return the value 0000.0000h. GLINT Gamma does not have an expansion ROM and so the expansion ROM base address is also read only, returning the value 0000.0000h.

### CFGBaseAddr0

Name	Type	Offset	Format
CFGBaseAddr0	Config	0x10	Bitfield

*Command register*

Bits	Name	Read	Write	Reset	Description
0...3	Address Type	✓	✗	0x0000.0000	0x0 Memory Space, not prefetchable, in 32 bit address space
4...16	Size indication	✓	✗		0x000 Indicates that the control registers must be mapped into 128 KBytes
17...31	Base Offset				Loaded at boot time to set offset of the control register space.

---

Notes: The Base Address 0 Register contains the GLINT Gamma control space offset. The control registers are in memory space. They are not prefetchable and can be located anywhere in 32 bit address space.

---

## CFGBaseAddr2

Name	Type	Offset	Format
CFGBaseAddr2	Config	0x18	Bitfield

*Command register*

Bits	Name	Read	Write	Reset	Description
0...3	Address Type	✓	✗	0x0000.0000	0h Memory Space, not prefetchable, in 32 bit address space
4...xx	Size Indication	✓	✗		These bits are zero, Region size set at configuration to 16M, 32M, 64M or disabled
31...xx	Base Address	✓	✗		<b>Loaded at boot time to set offset of the Multi GLINT aperture</b>

---

Notes: The Base Address 2 Register contains the base address of the Gamma Multi GLINT aperture, and defines the size and type of this region.

---

### 3.10 Gamma Functions

As a PCI multi-function device Gamma can have up to 4 functions. If Gamma is configured as AGP capable the Gamma function is always the first function. This is because the AGP capable function is always assumed to be the first function in a multi-function device. When not AGP capable the order of the functions is affected by the **ExtVGAMode** mode bits.

PCI Function	AGP / No VGA	Device 1 VGA	Device 3 VGA
0	Gamma Function	External Device 1	External Device 3
1	External Device 1	Gamma Function	Gamma Function
2	External Device 2	External Device 2	External Device 1
3	External Device 3	External Device 3	External Device 2
4			
5			
6			
7			

**Table 3-1 Gamma PCI Address Regions.**

---

---

# 4

# Region 0 - Control Registers

## 4.1 Region 0 Address Map

The Gamma Region Zero is a 128KByte region containing the control registers, and ports to and from the graphics processor. The control space is mapped in twice within the 128KByte region. In Delta compatible mode the second 64K the registers are mapped to be byte swapped for big endian hosts. Region zero can be configured in other ways for dual GLINT systems. See the **CSRAperture** register specification for details.

A large part of this region is not actually Gamma registers, but rather the registers of the GLINT Target device sitting below Gamma. This allows Gamma to be a transparent as possible to the driver software.

Address Range	Region Select	Register Location
0000.0000 -> 0000.0FFF	Control Status	Gamma / Target
0000.1000 -> 0000.1FFF	Target Control	Target
0000.2000 -> 0000.2FFF	GP FIFO Access	Gamma / Target
0000.3000 -> 0000.7FFF	Target Control	Target
0000.8000 -> 0000.FFFF	GP Registers	Gamma / Target
0001.0000 -> 0001.0FFF	Control Status	Gamma / Target
0001.1000 -> 0001.1FFF	Target Control	Target
0001.2000 -> 0001.2FFF	GP FIFO Access	Gamma / Target
0001.3000 -> 0001.7FFF	Target Control	Target
0001.8000 -> 0001.FFFF	GP Registers	Gamma / Target

Table 4-1 Region Zero Address Map.

## 4.2 Control Status Registers

The GLINT Gamma Control Status Register region is split into two sections. The lower section allows direct access to the control status registers of the GLINT rendering device connected to GLINT Gamma. Some of the registers in this section are actually GLINT Gamma registers which are shadowing GLINT 500TX or MX operations for software compatibility with systems without GLINT Gamma.

The upper section has additional GLINT Gamma registers which are documented below. Refer to the appropriate *GLINT 500TX* or *MX Hardware Reference Manual* for details on registers in the lower region.

Writes to any reserved or undefined registers in the Control Status area will be discarded; reads will return the value zero.

For information on the target register definitions please refer to the appropriate target Hardware Reference Manual.

Address Range	Register	Register Location	Notes
0000.0000	ResetStatus	Gamma/Target	1
0000.0008	IntEnable	Target	2
0000.0010	IntFlags	Target	2
0000.0018	InFIFOspace	Gamma	
0000.0020	OutFIFOWords	Target	2
0000.0028	DMAAddress	Gamma	
0000.0030	DMACount	Gamma	
0000.0038	ErrorFlags	Target	2
0000.0040	VClkCtl	Target	2
0000.0048	TestRegister	Target	2
0000.0050 - 0000.0058	Target Registers	Target	2
0000.0060	DMAControl	Gamma	
0000.0068	FIFODiscon	Target	2
0000.0070 - 0000.07F8	Target Registers	Target	2
0000.0080	OutDMA	Gamma	
0000.0088	OutDMACount	Gamma	
0000.0090 - 0000.03F8	Target Registers	Target	2
0000.0400 - 0000.07F8	Target Registers	Target	3
0000.0800	GResetStatus	Gamma	
0000.0808	GIntEnable	Gamma	
0000.0810	GIntFlags	Gamma	
0000.0818 - 0000.0830	Reserved	Gamma	
0000.0838	GErrorFlags	Gamma	
0000.0840	Reserved	Gamma	
0000.0848	GTestRegister	Gamma	
0000.0850 - 000.0860	Reserved	Gamma	
0000.0868	GFIFODis	Gamma	
0000.0870	GChipConfig	Gamma	
0000.0878	GCSRAperture	Gamma	
0000.0880 - 0000.0BF8	Reserved	Gamma	
0000.0C00	PageTableAddr	Gamma	
0000.0C08	PageTableLength	Gamma	
0000.0C10	Reserved	Gamma	
0000.0C18	Reserved	Gamma	

Address Range	Register	Register Location	Notes
0000.0C20	Reserved	Gamma	
0000.0C28	Reserved	Gamma	
0000.0C30	Reserved	Gamma	
0000.0C38	DelayTimer	Gamma	
0000.0C40	CommandMode	Gamma	
0000.0C48	CommandIntEnable	Gamma	
0000.0C50	CommandIntFlags	Gamma	
0000.0C58	CommandErrorFlags	Gamma	
0000.0C60	CommandStatus	Gamma	
0000.0C68	CommandFaulting Addr	Gamma	
0000.0C70	VertexFaultingAddr	Gamma	
0000.0C78	Reserved	Gamma	
0000.0C80	Reserved	Gamma	
0000.0C88	WriteFaultingAddr	Gamma	
0000.0C90	Reserved	Gamma	
0000.0C98	FeedbackSelectCount	Gamma	
0000.0CA0	Reserved	Gamma	
0000.0CA8	Reserved	Gamma	
0000.0CB0	Reserved	Gamma	
0000.0CB8	GammaProcessorMode	Gamma	
0000.0CC0 - 0000.0CF8	Reserved	Gamma	
0000.0D00	VGAShadow	Gamma	
0000.0D08	MultiGLINTAperture	Gamma	
0000.0D10	MultiGLINT1	Gamma	
0000.0D18	MultiGLINT2	Gamma	
0000.0D20 - 0000.0EF8	Reserved	Gamma	
0000.0F00	SerialAccess	Gamma	
0000.0F08 - 0000.0FF8	Reserved	Gamma	

**Table 4-2 Control Status Register Address Map**

*Note 1: Writing to this register Resets both the Target device and Gamma. The access is sent to the target and snooped by Gamma*

*Note 2: The specification for other Target Registers can be found in the appropriate Hardware Reference Manual*

*Note 3: The address offset range 0400h - 07F8h is passed through to the target device to allow visibility of the GLINT registers overlaid by Gamma registers. This is possible because not all address bits are used in the register space decode of GLINT chips.*



### 4.2.1 Reset Status Register

Writing to the reset status register forces a software reset of the GLINT Gamma Graphics Core. The software reset does not reset the GLINT Gamma primary PCI interface. It is provided for software diagnostics in case an incorrect register set up locks up the GLINT Gamma internal GC.

Various mode pins are sampled at reset, these pins are described in section 2.1.

#### DResetStatus

Name	Type	Offset	Format
DResetStatus	Config <i>Command register</i>	0x00	Bitfield

Bits	Name	Read	Write	Reset	Description
0...30	Reserved	✗	✗	0x00000000	
31	Software Reset Flag	✓	✓		0 = GLINT Gamma is ready for use 1 = GLINT Gamma is being reset and must not be used

Notes: The software reset takes a number of cycles and the GC must not be used during the reset. A flag in the register is provided which shows that the software reset is still in progress

#### InFIFOSpace

Name	Type	Offset	Format
CFGSerialEnable	Config <i>Command register</i>	0x18	Bitfield

Bits	Name	Read	Write	Reset	Description
0...31	Input FIFO Space	✓	✗	0x0000.002 1	The number of empty words in the input FIFO. This number of words can be written before checking “InFIFOSpace” again.

Notes: The Input FIFO Space register shows the number of words that can currently be written to the input FIFO. This register can be read at any time.

### 4.2.2 DMA Start Address

When using the legacy DMA controller to load the graphics processor, the DMA Start Address register should be loaded with the PCI address of the first word in the buffer to be transferred. In Queued DMA mode writes to this register are ignored.

Writing to the DMA Start Address register loads the address into the DMA address counter. Once a DMA has been initiated, the next DMA start address may be loaded. A read of this register returns the last start value loaded even if the DMA is already underway.

## DMAAddress

Name	Type	Offset	Format
DMAAddress	Config	0x28	Bitfield

*Command register*

Bits	Name	Read	Write	Reset	Description
0...31	DMA Start Address	✓	✓	0x0000.0000	PCI start address for PCI master read transfer to the graphics processor core.

Notes:

## DMACount

Name	Type	Offset	Format
DMACount	Config	0x30	Bitfield

*Command register*

Bits	Name	Read	Write	Reset	Description
0...23	DMA Count	✓	✓	0x0000.0000	Number of words to be transferred in the DMA operation
24...31	Reserved	✗	✗		

Notes: When using the legacy DMA controller to load the graphics processor, the DMA Count register should be loaded with the number of words to be transferred in the DMA operation. In Queued DMA mode writes to this register are ignored.

The action of loading a word greater than zero initiates the DMA operation. The value read back from this register indicates the current number of words left to be transferred. Writes to this register will be ignored if a DMA is in progress, but can be read at any time.

## DMAControl

Name	Type	Offset	Format
DMAControl	Region 0	0x60	Bitfield

Bits	Name	Read	Write	Reset	Description
0.	InDMA Byte Swap Control	✓	✓	0x0000.000 0	This field should only be changed when the InDMA controller is idle. 0 = Standard. 1 = Byte Swapped.
1	InDMA using AGP	✓	✓		0 = DMA uses PCI Master 1 = DMA uses AGP Master.
2	InDMA Data Throttle	✓	✓		0 = use AGP RBF# and IRDY# to throttle data. 1 = Only request data when space is available
3	AGP Long Read Disable	✓	✓		0 = AGP Long Read Requests may be generated. 1 = AGP Long Read Requests disabled.
4	OutDMA Byte Swap Control	✓	✓		This field should only be changed when the OutDMA controller is idle. 0 = Standard. 1 = Byte Swapped.
5	AGP Data Throttle	✓	✓		Applies to all AGP transfers 0 = Control data flow using bus protocols. 1 = Throttle Data requests based on FIFO space.
6	AGP High Priority	✓	✓		Applies to all AGP transferees 0 = Use AGP low priority reads. 1 = Use AGP high priority reads.
7...31	Reserved	✗	✗		

Notes: The DMA control register sets up the data transfer modes for the DMA controllers. Data transfer can be set to byte swapped for big endian hosts.

## OutDMAStartAddress

Name	Type	Offset	Format
OutDMAStartAddress	Region 0	0x80	Bitfield

*Command register*

Bits	Name	Read	Write	Reset	Description
0...31	Out DMA Start Address	✓	✓	0x0000.000 0	PCI start address for PCI master write transfer from the graphics processor core output FIFO

---

Notes: When using the Out DMA controller to upload the graphics processor output FIFO, the Out DMA Start Address register should be loaded with the PCI address where the first word of the upload data is to be transferred.

Writing to the OutDMA Start Address register loads the address into the OutDMA address counter. Once a DMA has been initiated, the next DMA start address may be loaded. A read of this register returns the last start value loaded even if the DMA is already underway.

---

## OutDMACount

Name	Type	Offset	Format
OutDMACount	Region 0	0x88	Bitfield

*Command register*

Bits	Name	Read	Write	Reset	Description
0...23	DMA Count	✓	✓	0x0000.0000	Number of words to be transferred in the DMA operation
24...31	Reserved	✗	✗		

---

Notes: The Out DMA Count register should be loaded with the number of words to be transferred in the DMA operation. The action of loading a word greater than zero initiates the DMA operation. The value read back from this register indicates the current number of words left to be transferred. Writes to this register will be ignored if it is non-zero, but can be read at any time.

---

## GResetStatus

Name	Type	Offset	Format
GResetStatus	Region 0	0x800	Bitfield

*Control register*

Bits	Name	Read	Write	Reset	Description
0...30	Reserved	✗	✗		
31	Software Reset Flag	✓	✓	0x0000.0000	0 = Gamma is ready for use. 1 = Gamma is being reset and must not be used.

---

Notes: Writing to the reset status register causes a software reset of Gamma. The software reset does not reset the bus interface. The reset takes a number of cycles to complete during which the graphics processor should not be used. A flag in the register shows that the software reset is still in progress.

The GResetStatus register is different to the ResetStatus register in that only the Gamma device is reset, not the Target Device below Gamma. This register is normally for hardware diagnostic purposes only. The software operation is undefined if the Gamma is reset without resetting the Target Device.

---

## GIntEnable

<b>Name</b>	<b>Type</b>	<b>Offset</b>	<b>Format</b>
GIntEnable	Region 0 <i>Command register</i>	0x808	Bitfield

Bits	Name	Read	Write	Reset	Description
0	DMA Interrupt Enable	✓	✓	0x0000.0000	0 = Disable interrupt. 1 = Enable interrupt.
1-2	Reserved	✗	✗		
3	Error Interrupt Enable	✓	✓		0 = Disable interrupt. 1 = Enable interrupt.
4...12	Reserved	✗	✗		
13	Command Interrupt Enable	✓	✓		0 = Disable interrupt. 1 = Enable interrupt.
14...31	Reserved	✗	✗		

---

Notes: The Interrupt Enable Register selects which internal conditions are permitted to generate a bus interrupt. Three interrupt sources are defined below. At reset all interrupt sources are disabled.

---

## GIntFlags

Name	Type	Offset	Format
GIntFlags	Region 0 <i>Control register</i>	0x810	Bitfield

Bits	Name	Read	Write	Reset	Description
0	DMA Flag	✓	✓	0x0000.000 0	0 = No interrupt. 1 = Interrupt outstanding.
1...2	Reserved	✗	✗		
3	Error Flag	✓	✓		0 = No interrupt. 1 = Interrupt outstanding.
4...12	Reserved	✗	✗		
13	Command Interrupt Flag	✓	✓		Flag set when any bits set in the Command Interrupt Flags register 0 = No interrupt. 1 = Interrupt outstanding.
14...31	Reserved	✗	✗		

Notes: The Interrupt Flags Register shows which interrupts are outstanding. Flag bits are reset by writing to this register with the corresponding bit set to a one. Flags at positions where the bits are set to zero will be unaffected by the write. The exception to this is bit 13, which is the Command interrupt Flag. This bit is cleared by clearing all bits the Command Unit Interrupt Flags Register **CommandIntFlags**.

## GErrorFlags

Name	Type	Offset	Format
GErrorFlags	Region 0 <i>Command register</i>	0x838	Bitfield

Bits	Name	Read	Write	Reset	Description
0	Input FIFO Error Flag	✓	✓	0x0000.000 0	Number of words to be transferred in the DMA operation
1....2	Reserved	✗	✗		
3	DMA Error Flag	✓	✓		Flag set for direct or register access to input FIFO while DMA is in progress (i.e. when the DMACount register is not zero). 0 = No error. 1 = Error outstanding.

4...6	Reserved	X	X		
7	PCI Master Error Flag	✓	✓		Flag set when either Master abort or Target abort occurs while PCI Master access in progress. - The CFGStatus register can be read to determine the type of error. 0 = No error. 1 = Error outstanding.
8	Reserved	X	X		
9	In DMA Overwrite Error Flag	✓	✓		Flag set in legacy mode if the InDMACount register is written when it is not zero 0 = No error. 1 = Error outstanding.
10	Out DMA Overwrite Error Flag	✓	✓		Flag set in legacy mode if the OutDMACount register is written when it is not zero 0 = No error. 1 = Error outstanding.
11...12	Reserved	X	X		
13	Command Error Flag				Flag set when any bits set in the Command Error Flags register 0 = No error. 1 = Error outstanding
14...31	Reserved	X	X		

Notes: The Error Flags register shows which errors are outstanding in Gamma. Flag bits are reset by writing to this register with the corresponding bit set to a one. Flags at positions where the bits are set to zero will be unaffected by the write. The exception to this is bit 13, which is the Command Error Flag. This bit is cleared by clearing all bits the Command Unit Error Flags Register.

## GTestRegister

<b>Name</b>	<b>Type</b>	<b>Offset</b>	<b>Format</b>
GTestRegister	Region 0	0x848	Bitfield
	<i>Command register</i>		

Bits	Name	Read	Write	Reset	Description
0...23	DMA Count	✓	✓	0x0000.0000	Number of words to be transferred in the DMA operation
24...31	Reserved	X	X		

Notes: For hardware test purposes only. Setting a bit in this register causes the corresponding unit to be put into test mode.



## DFIFODis

Name	Type	Offset	Format
DFIFODis	Region 0	0x868	Bitfield

*Command register*

Bits	Name	Read	Write	Reset	Description
0.	Input FIFO Disconnect enable	✓	✓	0x0000.0000	0 = Disabled (RESET) 1 = Enabled
1...31	Reserved	✗	✗		

---

Notes: The FIFO Disconnect Register enables input FIFO disconnect on GLINT Gamma. Disconnect is disabled at reset.

---

## GChipConfig

Name	Type	Offset	Format
GChipConfig	Region 0	0x870	Bitfield

*Command register*

Bits	Name	Read	Write	Reset	Description
0	AGPCapable	✓	✓	configured	0 = AGP Capable 1 = AGP Capable
1	SBACapable	✓	✓		0 = AGP sideband Addressing Disable 1 = AGP sideband Addressing Enable
2	BaseClassZero	✓	✓		0 = use the correct PCI Base Class Code 1 = force PCI Base Class Code to be zero
3...4	MinGrant[7:6]	✓	✗		Top 2 bits of the PCI Minimum Grant Configuration Register
5...6	MaxLat[7:6]	✓	✗		Specifies how often the PCI device needs to gain access to the PCI bus.
7	ExtDevice1	✓	✗		Enable External device 1
8	ExtDevice2	✓	✗		Enable External device2
9	ExtDevice3	✓	✗		Enable External device3
10...11	ExtVGAMode	✓	✓		0 = No VGA 1 = External Device 1 is a VGA device 2 = External Device 3 is a VGA device 3 = No VGA

12	VGANonAlias	✓	✓		0 = enable VGA 10 bit address aliased decoding 1 = disable VGA 10 bit address aliased decoding (Do 32bit decode)
13...16	VGAControl	✓	✓		
17	GlntEn1	✓	✗		1 = External Device 1 is a GLINT device 0 = External Device 1 is any other device
18	GlntEn2	✓	✗		1 = External Device 2 is a GLINT device 0 = External Device 2 is any other device
19...20	Multi GLINTAp	✓	✗		Indicates the MultiGLINT aperture size. 0 = 0 MBytes. 1 = 16 MBytes 2 = 32 MBytes 3 = 64 MBytes
21...31	Reserved	✗	✗		

Notes: Most of Gamma configuration bits are visible through the GChipConfig. This register can then be read back over the PCI bus, to allow the host to determine how the Gamma chip has been configured, and to modify various fields of the configuration if required.

Note: *If both GlntEn1 and GlntEn2 are not set then these bits are ignored and the Multi-GLINT aperture size is set to 0MBytes.*

## CSRAperture

<b>Name</b>	<b>Type</b>	<b>Offset</b>	<b>Format</b>
CSRAperture	Region 0	0x878	Bitfield
	<i>Command register</i>		

Bits	Name	Read	Write	Reset	Description
0	CSRView DualGLINT	✓	✓	0x0000.000 0	0 = Low CSR 64K accesses Master GLINT Little Endian High CSR 64K accesses Master GLINT Big Endian 1 = Low CSR 64K accesses Master GLINT High CSR 64K accesses Secondary GLINT Endian set by CSRByteSwap
1	CSRByteSwap	✓	✓		This control bit has no effect unless the CSRViewDualGLINT bit is set 0 = All CSR accesses are little endian 1 = All CSR accesses are big endian

2	CSRGLINT Select	✓	✓		This control bit has no effect except in a dual GLINT system as defined by the Gamma configuration bits. 0 = The Device 1 GLINT is the Master 1 = The Device 2 GLINT is the Master
3...31	Reserved	✗	✗		All bits zero

Notes: The Gamma CSR Aperture Control Register allows the accesses to Gamma and the GLINT chip behind to be configured in a number of different ways for a dual GLINT system. The register is reset to the Delta compatible configuration.

*Note this register has no effect on the region 0 space unless Gamma is controlling a dual GLINT system.*

## PageTableAddr

<b>Name</b>	<b>Type</b>	<b>Offset</b>	<b>Format</b>
PageTableAddr	Region 0	0xC00	Bitfield

*Command register*

Bits	Name	Read	Write	Reset	Description
0...11	Reserved	✗	✗	0x0000.0000	
12...31	Page Table Address	✗	✗		

Notes: The Page Table Address register holds the physical address of the page table used during the logical to physical mapping. The base address is given as a byte address, but must be on a 4K byte boundary.

### 4.2.3 Page Table Length Register

The Page Table Length register holds the length, in units of 4K bytes, of the page table. It is only used for some basic range checking.

## PageTableLength

Name	Type	Offset	Format
PageTableLength	Region 0	0xC08	Bitfield

*Command register*

Bits	Name	Read	Write	Reset	Description
0...9	Page Table Length	✓	✓	0x0000.0000	Number of words to be transferred in the DMA operation
10...31	Reserved	✗	✗		

Notes: When using the legacy DMA controller to load the graphics processor, the DMA Count register should be loaded with the number of words to be transferred in the DMA operation. In Queued DMA mode writes to this register are ignored.

The action of loading a word greater than zero initiates the DMA operation. The value read back from this register indicates the current number of words left to be transferred. Writes to this register will be ignored if a DMA is in progress, but can be read at any time.

## DelayTimer

Name	Type	Offset	Format
DelayTimer	Region 0	0xC38	Bitfield

*Command register*

Bits	Name	Read	Write	Reset	Description
0...31	Delay Timer Count	✓	✓	0x0000.0000	

Notes: The Delay Timer Register, when written to, starts a timer. When the timer reaches one an interrupt is generated and the timer stops. Writing zero aborts the timer with no interrupt being generated. Reading this register returns the current timer value.

## CommandMode

**Name** CommandMode  
**Type** Region 0  
**Offset** 0xC40  
**Format** Bitfield  
*Command register*

Bits	Name	Read	Write	Reset	Description
0...1	Command Unit Operation	✓	✓	0x0000.0000	0 = Legacy DMA operation 1 = Queued DMA operation 2 = Reserved 3 = Reserved
2	Logical addressing	✓	✓		0 = Disable logical addressing 1 = Enable logical addressing
3	Abort Output DMA	✓	✓		0 = Normal operation 1 = Abort Output DMA
4...5	Reserved	✗	✗		
6	Abort Input DMA	✓	✓		0 = Normal operation 1 = Abort Input DMA
7...31	Reserved	✗	✗		

---

Notes: The Command Mode Register controls the operation of the Command Unit.

---

## CommandIntEnable

**Name** CommandIntEnable  
**Type** Region 0  
**Offset** 0xC48  
**Format** field  
*Command register*

Bits	Name	Read	Write	Reset	Description
0	FIFO Queued Command DMA Interrupt Enable	✓	✓	0x0000.0000	0 = Interrupt disabled 1 = Interrupt enabled
1	Output DMA Interrupt Enable	✓	✓		0 = Interrupt disabled 1 = Interrupt enabled
2	Command Interrupt Enable	✓	✓		0 = Interrupt disabled 1 = Interrupt enabled

3	Timer Interrupt Enable	✓	✓		
4	Command Error Interrupt Enable	✓	✓		0 = Interrupt disabled 1 = Interrupt enabled
5...7	Reserved	✗	✗		
8	Page Fault Command Interrupt Enable	✓	✓		0 = Interrupt disabled 1 = Interrupt enabled
9	Page Fault Vertex Interrupt Enable	✓	✓		0 = Interrupt disabled 1 = Interrupt enabled
10...11	Reserved	✗	✗		
12	Page Fault Write Interrupt Enable	✓	✓		0 = Interrupt disabled 1 = Interrupt enabled
13...31	Reserved	✗	✗		

Notes: The Command Interrupt Enable Register selects which command conditions are permitted to generate a bus interrupt. At reset all interrupt sources are disabled.

## CommandIntFlags

<b>Name</b>	<b>Type</b>	<b>Offset</b>	<b>Format</b>
CommandIntFlags	Region 0	0xC50	Bitfield

*Command register*

Bits	Name	Read	Write	Reset	Description
0	FIFO Queued Command DMA Flag	✓	✓	0x0000.0000	0 = No flag 1 = flag
1	Output DMA Flag	✓	✓		0 = No flag 1 = flag
2	Command Flag	✓	✓		0 = No flag 1 = flag
3	Timer Flag	✓	✓		0 = No flag 1 = flag
4	Command Error Flag	✓	✓		0 = No flag 1 = flag
5...7	Reserved	✗	✗		
8	Page Fault Command Flag	✓	✓		0 = No flag 1 = flag



20	Page Fault Write Access Write error	✓	✓		0 = No error 1 = Error
21	Reserved	✗	✗		
22	Illegal DMA Tag error	✓	✓		0 = No error 1 = Error
23..31	Reserved	✗	✗		

Notes: The Command Error Flags register shows which errors are outstanding in the Gamma Command Unit. Flag bits are reset by writing to this register with the corresponding bit set to a one. Flags at positions where the bits are set to zero will be unaffected by the write.

## CommandStatus

<b>Name</b>	<b>Type</b>	<b>Offset</b>	<b>Format</b>
CommandStatus	Region 0	0xC60	Bitfield

*Command register*

Bits	Name	Read	Write	Reset	Description
0	Command DMA busy	✓	✓	0x0000.000 4	0 = Idle 1 = Busy
1	Output DMA Busy	✓	✓		0 = Idle 1 = Busy
2	Input FIFO Empty	✓	✓		0 = Not empty 1 = Empty
3..31	Reserved	✗	✗		

Notes: The Command Status register is a read only register which gives information about the current Command unit status.

## CommandFaultingAddr

<b>Name</b>	<b>Type</b>	<b>Offset</b>	<b>Format</b>
CommandFaultingAddr	Region 0	0xC6	Bitfield

*Command register*



Bits	Name	Read	Write	Reset	Description
0...31	Command Faulting Address	✓	✗	0x0000.0000	

Notes: The Command Faulting Address register hold the logical address of an Input DMA access which caused a Command Fault interrupt, or caused one of the three possible logical to physical mapping errors.

### VertexFaultingAddr

**Name** VertexFaultingAddr      **Type** Region 0      **Offset** 0xC70      **Format** Bitfield  
*Command register*

Bits	Name	Read	Write	Reset	Description
0...31	Vertex Faulting Address	✓	✓	0x0000.0000	Number of words to be transferred in the DMA operation

Notes: Vertex Faulting Address register hold the logical address of a Rectangle Read DMA access which caused a Vertex Fault interrupt, or caused one of the three possible logical to physical mapping errors.

### WriteFaultingAddr

**Name** WriteFaultingAddr      **Type** Region 0      **Offset** 0xC88      **Format** Bitfield  
*Command register*

Bits	Name	Read	Write	Reset	Description
0...31	Write Faulting Address	✓	✓	0x0000.0000	Number of words to be transferred in the DMA operation

Notes: The Write Faulting Address register hold the logical address of an Write DMA access which caused a Write Fault interrupt, or caused one of the three possible logical to physical mapping errors.

## FeedbackSelectCount

Name	Type	Offset	Format
FeedbackSelectCount	Config	0x30	Bitfield

*Command register*

Bits	Name	Read	Write	Reset	Description
0...23	Feedback Select Count	✓	✗	0x0000.0000	
24...30	Reserved	✗	✗		
31	Feedback Select Count Overflow	✓	✗		0 = No overflow 1 = Overflow

---

Notes: The operation of this register is currently defined in the Command Unit Specification

---

### 4.2.4 Gamma Processor Mode Register

## GammaProcessorMode

Name	Type	Offset	Format
GammaProcessorMode	Region 0	0x30	Bitfield

*Command register*

Bits	Name	Read	Write	Reset	Description
0	Delta Enable	✓	✓	0x0000.0000	0 = Delta unit enabled 1 = Delta unit disabled
1..31	Reserved	✗	✗		

---

Notes: The Gamma Processor Mode register allows the user to disable the Delta unit in Gamma. This is to allow a target chip Delta unit to be used instead.

---

## VGAShadow

Name	Type	Offset	Format
VGAShadow	Region 0	0xD00	Bitfield

*Command register*

Bits	Name	Read	Write	Reset	Description
0	VGA IO Color decode	✓	✓	0x0000.0001	1 = Decode IO color space 3DXh 0 = Decode VGA monochrome space 3BXh
1	VGA Memory enable				0 = Disable VGA memory 1 = Enable VGA memory
2...3	VGA Memory region Select				00b = A0000h - BFFFFh (128K) 01b = A0000h - AFFFFh (64K) 10b = B0000h - B7FFFh (32K) 11b = B8000h - BFFFFh (32K)
4...31	Reserved	✗	✗		

---

Notes: The VGA shadow control register allows the readback, and also writing of the VGA IO space shadow bits. This allows the VGA shadowing to be set without the use of IO space accesses.

---

## MultiGLINTAperture

Name	Type	Offset	Format
MultiGLINTAperture	Region 0	0xD08	Bitfield

*Command register*

Bits	Name	Read	Write	Reset	Description
0...1	Input X Span	✓	✓	0x0000.0000	00b = Input X span is 1Kbytes 01b = Input X span is 2Kbytes 10b = Input X span is 4Kbytes 11b = Input X span is 8Kbytes
2	Product Select	✓	✓		0 = Use 2x product 1 = Use 16x product (This is used for X Spans of 800 and 1600)
3	1x Product Enable	✓	✓		
4	16x / 2x Product Enable	✓	✓		
5	4x Product Enable	✓	✓		
6	8x Product Enable	✓	✓		
7...9	Post Multiply	✓	✓		000b = x8. 001b = x16. 010b = x32. 011b = x64. 100b = x128. 101b = x256 All other values = x8
10...11	GLINT Aperture Size	✓	✓		00b = 4M. 01b = 8M. 10b = 16M. 11b = 32M
12.31	Reserved	✗	✗		

Notes: The Multi-GLINT aperture control register controls the operation of the Multi-GLINT aperture. The control bits define X spans and Y multiply controls to allow the use of non shared framebuffer GLINT systems behind Gamma.

## MultiGLINT1

**Name** MultiGLINT1      **Type** Region 0      **Offset** 0xD10      **Format** Bitfield  
*Command register*

Bits	Name	Read	Write	Reset	Description
0...21	Reserved	✗	✗	0x0000.0000	
22..31	GLINT 1 Base Address	✓	✓		

---

Notes: The Multi GLINT Base 1 Register should be loaded with the framebuffer base address of the First GLINT in a multi-GLINT system which uses the multi-GLINT aperture.

---

## MultiGLINT2

**Name** MultiGLINT2      **Type** Region 0      **Offset** 0xD18      **Format** Bitfield  
*Command register*

Bits	Name	Read	Write	Reset	Description
0...21	Reserved	✗	✗	0x0000.0000	
22..31	GLINT 2 Base Address	✓	✓		

---

Notes: The Multi-GLINT Base 2 Register should be loaded with the framebuffer base address of the Second GLINT in a multi-GLINT system which uses the multi-GLINT aperture.

---

## SerialAccess

Name	Type	Offset	Format
SerialAccess	Region 0	0xF00	Bitfield

*Command register*

Bits	Name	Read	Write	Reset	Description
0	Serial EEPROM Data Pin	✓	✓	0x0000.000 0	
1..31	Reserved	✗	✗		

---

Notes: This register is used to access the Configuration Serial EEPROM. Reads and writes of the EEPROM can be initiated by setting up the correct stream of read and write accesses to the bottom bit of this register. For details of the read / write patterns to be used, see the XICOR data sheet on the X84041 operation. Note the EEPROM is also programmable and readable through a configuration register.

---

### 4.3 Graphics Core Registers

All the Graphics Core registers in the GLINT Gamma, GLINT 500TX and MX are addressed in this part of region 0. The address for each register and associated data fields is defined in the appropriate Programmers Reference Manual.

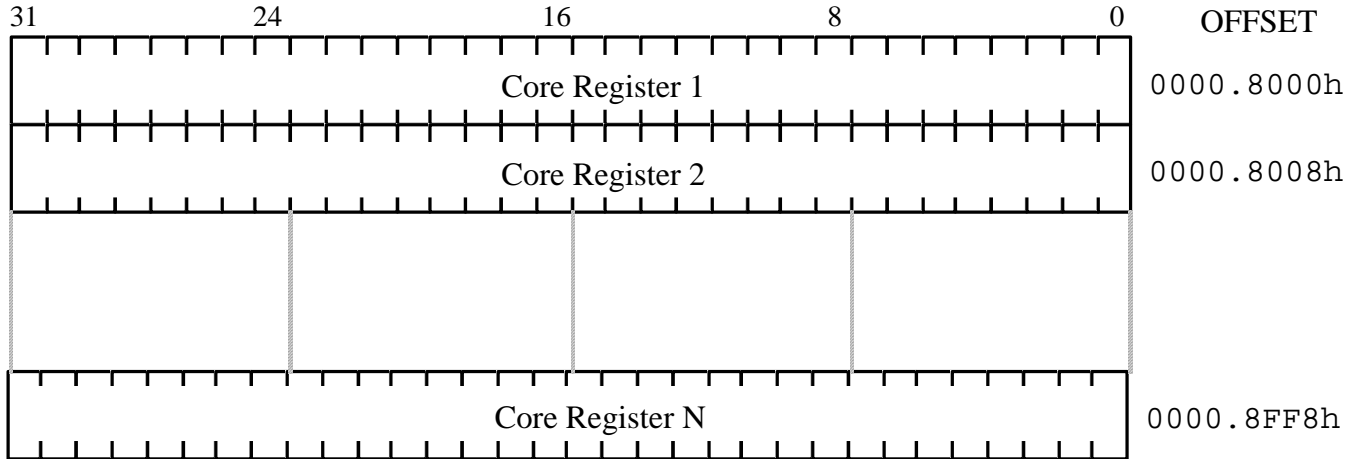

Figure 4-1 Graphics Core Registers

*Note: Not all the available register locations are used within the Graphics Core. The registers are on 64 bit boundaries*

### 4.4 Graphics Core FIFO Interface

The Graphics Core FIFO interface provides a port through which both GC register addresses and data can be sent to the input FIFO. A range of 4 KBytes of host space is provided although all data may be sent through one address in the range. ALL accesses go directly to the FIFO, the range is provided to allow for data transfer schemes which force the use of incrementing addresses. Before writing to the input FIFO the user must check that there is sufficient space by reading the InFIFOSpace register.

If the FIFO interface is used, then data is typically sent to the GLINT Gamma in pairs, an address word which addresses the register to be updated, followed by the data to be sent to the register.

*Note: The GC registers can not be read through this interface. Command buffers generated to be sent to the input FIFO interface may be read directly by the GLINT Gamma by using the DMA controller.*

A data formatting scheme is provided to allow for multiple data words to be sent with one address word where adjacent or grouped registers are being written, or where one register is to be written many times.

For more information on the direct FIFO interface data buffer formats please refer to the GLINT Gamma, GLINT 500TX and MX Programmers Reference Manuals.

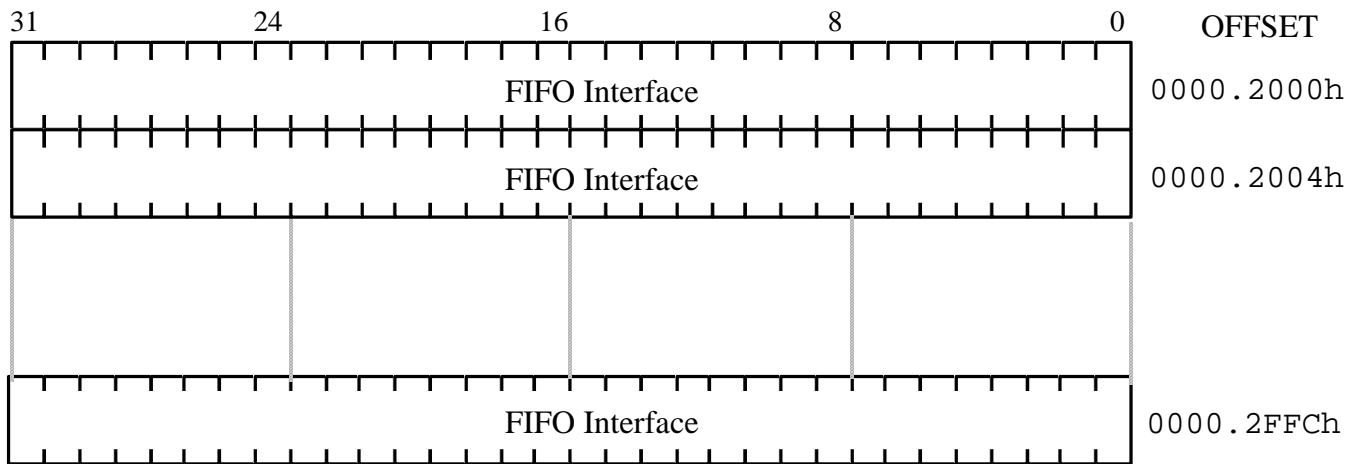

**Figure 4-2 Graphics Core FIFO Interface**

*Note: The FIFO interface can be accessed at 32 bit boundaries. This is to allow a direct copy from a DMA format buffer.*



## 5

**Electrical Data****5.1 Absolute Maximum Ratings**

Junction Temperature	100°C
Storage Temperature	-65°C to 150°C
I/O DC Supply Voltage (VDD2)	3.6V
Core DC Supply Voltage (VDD)	2.62V
I/O Pin Voltage with respect to GND	-0.5V to 3.6V

Table 5-1 Absolute Maximum Ratings

**5.2 DC Specifications**

Symbol	Parameter	Min	Max	Unit
VDD2	I/O Supply Voltage	3.0	3.6	V
VDD	Core Supply Voltage	2.35	2.62	
L <sub>PIN</sub>	Pin Inductance			nH
I <sub>CC</sub>	Power Supply Current			mA

Table 5-2 DC Specifications

Symbol	Parameter	Min	Max	Unit
V <sub>PIL</sub>	Input Low Voltage		0.8	V
V <sub>PIH</sub>	Input High Voltage	2.0		V
V <sub>POL</sub>	Output Low Voltage		0.5	V
V <sub>POH</sub>	Output High Voltage	2.4		V
I <sub>PIL</sub>	Input Low Current		Note 1	mA
I <sub>PIH</sub>	Input High Current		Note 1	mA
C <sub>PIN</sub>	Input Capacitance		10	pF

Symbol	Parameter	Min	Max	Unit
C <sub>CLK</sub>	PCI/AGP Clock Input Capacitance	5	12	pF
C <sub>IDSEL</sub>	PCI Idsel Input Capacitance		8	pF

**Table 5-3 PCI Signal DC Specifications**

Note: This value is PCI 2.1 compliant

### 5.3 AC Specifications

Pin Name	Capacitive Load
PCIAD[31:0], PCICBEN[3:0], PCIPar, PCIFrameN, PCIIRdyN, PCITRdyN, PCIStopN, PCIIdsel, PCIDevselN, PCIReqN, PCIGntN, PCIIntAN, AGPPipeN, AGPRbfN, AGPSBA[7:0], SCIAD[31:0], SCICBEN[3:0], SCIPar, SCIFrameN[1:0], SCIIRdyN[1:0], SCITRdyN[1:0], SCIStopN[1:0], SCIDevselN[1:0].	50pF in PCI 33 system. 10pF in AGP system
SCIClkOut[3:0], PCIFIFOInDis.	20pF

**Table 5-4 Test Loads for AC Timing**

### 5.1.1 Clock Timing

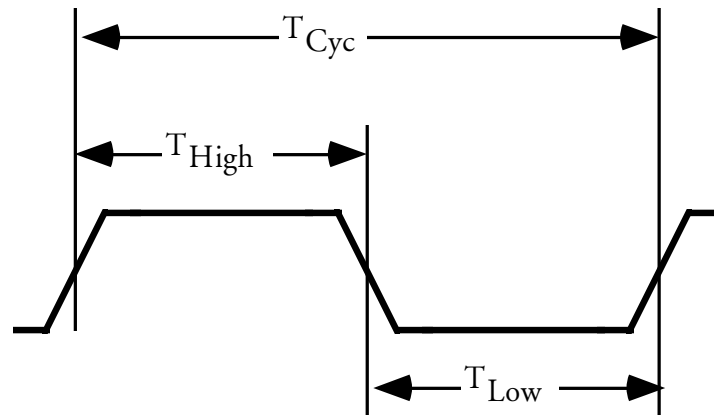

Figure 5-1 Clock Waveform Timing

Symbol	Parameter	Min	Max	Units	Notes
$T_{PCyc}$	PCI/AGPclk Cycle Time	15		ns	
$T_{PHigh}$	PCI/AGPclk High Time	6		ns	
$T_{PLow}$	PCI/AGPclk Low Time	6		ns	
$T_{MCyc}$	Mclk Cycle Time	9.25		ns	
$T_{MHigh}$	Mclk High Time	3.5		ns	
$T_{MLow}$	Mclk Low Time	3.5		ns	
$T_{SCyc}$	SCIClk Cycle Time	15		ns	
$T_{SHigh}$	SCIClk High Time	6		ns	
$T_{SLow}$	SCIClk Low Time	6		ns	

Table 5-5 Clock Waveform Timing

### 5.1.2 Input / Output Timing

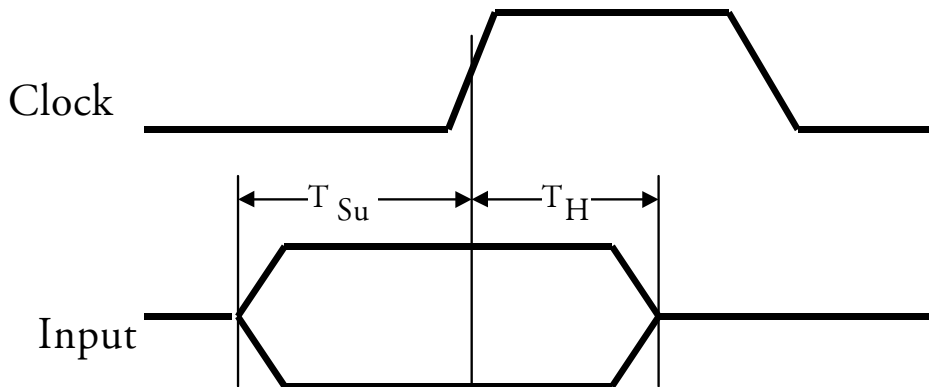

Figure 5-2 Clock Referenced Input Timing

Parameter	TSu Min	TH Min	Units	Notes
PCIAD(31:0), PCICBEN(3:0), PCIPar, PCIFrameN, PCIIRdyN, PCITRdyN, PCIStopN, PCIIIdsel, PCIDevselN, AGPSt[2:0]	5	0	ns	
PCIGntN	5	0	ns	
PCIRstN	7	0	ns	1

Table 5-6 PCIClk Referenced Input Timing

Note 1: PCIRstN is resynchronized internally. The given timings, when met, ensure that the reset is detected in the current cycle.

Parameter	TSu Min	TH Min	Units	Notes
SCIAD(31:0), SCICBEN(3:0), SCIPar, SCIIRdyN(1:0), SCITRdyN(1:0), SCIStopN(1:0), SCIDevselN(1:0), GLINTInDis(1:0), GLINTOutDis(1:0), SCIReqN	5	0.2	ns	
ModeCtl(1:0), VGAEn, ExtFuncEn(1:0)	10	2	ns	

**Table 5-7 SCIClk Referenced Input Timing**

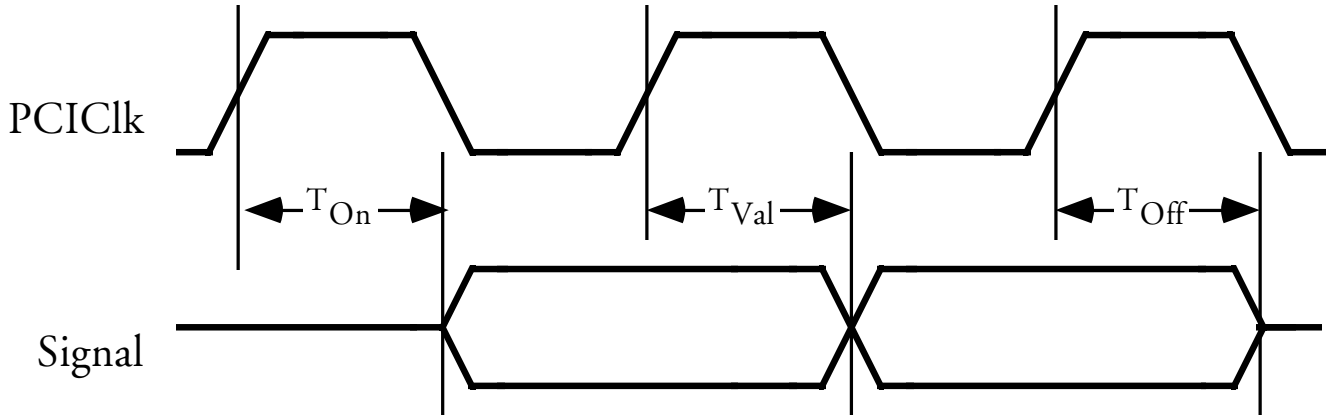

**Figure 5-3 PCIClk Referenced Output Timing**

Parameter	TVal		TOn		TOff		Units	Notes
	Min	Max	Min	Max	Min	Max		
PCIAD(31:0), PCICBEN(3:0), PCIPar, PCIFrameN, PCIIRdyN, PCITRdyN, PCIStopN, PCIIIdsel, PCIDevselN	2	11	2	11	2	11	ns	
PCIReqN	2	12					ns	
PCIIIntAN	2	15					ns	1

**Table 5-8 PCIClk 33MHz Referenced Output Timing**

*Note 1: Timings given are for falling edges of the open drain signal. Rise times are dependent on the external pull-up resistor.*

Parameter	TVal		TOn		TOff		Units	Notes
	Min	Max	Min	Max	Min	Max		
PCIAD(31:0), PCICBEN(3:0), PCIPar, PCIFrameN, PCIIRdyN, PCITRdyN, PCIStopN, PCIIIdsel, PCIDevselN	1.5	6	1.5	6	2	11	ns	
PCIReqN	1.5	6					ns	
PCIIIntAN	1.5	6					ns	1

**Table 5-9 PCIClk 66MHz Referenced Output Timing**

*Note 1: Timings given are for falling edges of the open drain signal. Rise times are dependent on the external pull-up resistor.*

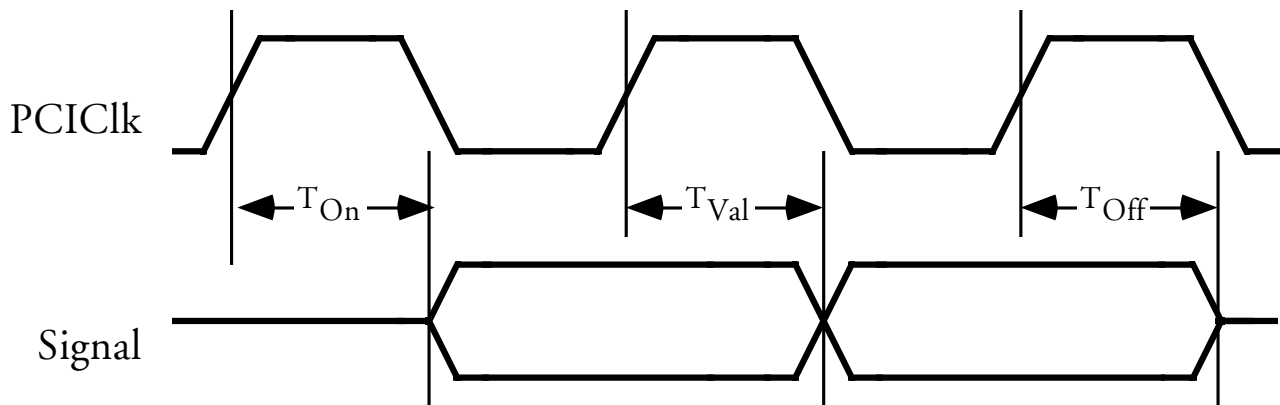

Figure 5-4 SCIClk Referenced Output Timing

Parameter	$T_{val}$		$T_{On}$		$T_{Off}$		Units	Notes
	Min	Max	Min	Max	Min	Max		
SCIAD(31:0), SCICBEN(3:0), SCIPar, SCIFrameN, SCIIRdyN, SCITRdyN, SCIStopN, SCIDevselN	1.5	7	1.5	7	1.5	7	ns	
SCIGntN	1.5	7					ns	

Table 5-10 SCIClk Referenced Output Timing

## 6

## Pin Information

## 6.1 Pin Characteristics

The Gamma2 package is a standard 304 ball PQFP part. The pins are shown individually in listings sorted by (a) name and (b) number. Pad number sequence is Counter Clockwise. Pin 1 is on left side of South edge.

Item	Description
Total Package Signal I/O	228 pins
TEST I/O	64 pins
GND	52 ( 44 Package GNDs )
VDD	40 ( 16 Package VDDs )
VDD2	40 ( 16 Package VDD2s )
N/C	No connection
Pads per side	122

Table 6-1 Pin characteristics

PKG PAD	PKG BALL
GND	A1, F1, K1, P1, V1, AC1, B2, AB2, C3, AA3, D4, H4, M4, T4, Y4, A6, AC6, D8, Y8, A10, AC10, D12, Y12, A14, AC14, D16, Y16, A18, AC18, D20, H20, M20, T20, Y20, C21, AA21, B22, AB22, A23, F23, K23, P23, V23, AC23
PWR	J4, L4, N4, R4, D9, Y9, D11, Y11, D13, Y13, D15, Y15, J20, L20, N20, R20
PWR2	E4, G4, U4, W4
PWR3	Y5, Y7, Y17, Y19
PWR4	E20, G20, U20, W20
PWR5	D5, D7, D17, D19

Table 6-2 Ground and Power pin locations

### 6.1.1 Pinlist by Pin name

No.	Function	Pad	Ball Function	Name	Fields
140	SIG	535	H22	AGPPipeN	
135	SIG	36	G21	AGPRbfN	
128	SIG	531	F22	AGPSBA[2]	
127	SIG	34	E21	AGPSBA[3]	GRA_Scan_Bypass>OFLAG=BDY;KFLAG=-SG;SP_WAFER_BYPASS=+TI;WRP_DC_BYPASS=+TI
126	SIG	33	E22	AGPSBA[4]	
119	SIG	30	B21	AGPSBA[5]	Test_AClk_in>KFLAG=-AC
118	SIG	29	B20	AGPSBA[6]	Test_BClk_in>KFLAG=-BC
117	SIG	28	B19	AGPSBA[7]	Test_CClk_in>KFLAG=-SC
139	SIG	37	C22	AGPSBA_ModeCtl[0]	Boundary_Scan_Enable>KFLAG=+SG
131	SIG	35	F21	AGPSBA_ModeCtl[1]	
159	SIG	41	J21	AGPSt[0]	
151	SIG	40	C23	AGPSt[1]	Unused_test_pad>
144	SIG	536	H21	AGPSt[2]	
240	SIG	60	Y22	ExtFuncEn[0]	DI1(0)_NonTest_I/O_driver_inhibit>OFLAG=-BI;KFLAG=-OI;MACRO=-TI;WRP_DC=-TI;SP_WAFER=-TI;WRP_DC_BYPASS=-TI;SP_WAFER_BYPASS=-TI
364	SIG	93	AA4	ExtFuncEn[1]	DI2(0)_Test_I/O_driver_inhibit>OFLAG=-BI;KFLAG=+SG
427	SIG	108	R1	GLINTInDis[0]	
439	SIG	111	L1	GLINTInDis[1]	
447	SIG	113	H1	GLINTOutDis[0]	
443	SIG	112	J2	GLINTOutDis[1]	
65	GND	16	A11	GND	
69	GND	17	A12	GND	GND>
337	GND	85	AA8	GND	GND>
321	GND	81	AB9	GND	GND>
309	GND	78	AC13	GND	GND>
187	GND	47	L23	GND	GND>
435	GND	110	M1	GND	GND>



No.	Function	Pad	Ball Function	Name	Fields
191	GND	48	M23	GND	GND>
415	GND	105	W1	GND	GND>
455	SIG	115	E1	MClk	Clock_input>KFLAG=+SG
312	SIG	579	AA10	N/C	
304	SIG	575	AA12	N/C	
300	SIG	573	AA13	N/C	
241	SIG	61	AA22	N/C	Unused_pin_and_test_pad>
354	SIG	589	AA6	N/C	
332	SIG	583	AA9	N/C	
310	SIG	578	AB10	N/C	
302	SIG	574	AB12	N/C	
264	SIG	565	AB16	N/C	
256	SIG	563	AB17	N/C	
320	SIG	581	AC9	N/C	
58	SIG	514	B12	N/C	
66	SIG	518	B14	N/C	
10	SIG	503	B7	N/C	
60	SIG	515	C12	N/C	
50	SIG	511	D10	N/C	
114	SIG	530	D18	N/C	
125	SIG	32	D21	N/C	
474	SIG	618	F2	N/C	
130	SIG	532	F20	N/C	
476	SIG	619	F3	N/C	
482	SIG	620	F4	N/C	
132	SIG	533	G22	N/C	
442	SIG	611	J1	N/C	
454	SIG	613	J3	N/C	
432	SIG	608	K2	N/C	
172	SIG	541	K20	N/C	
434	SIG	609	K3	N/C	
436	SIG	610	K4	N/C	
428	SIG	606	L2	N/C	
430	SIG	607	L3	N/C	
424	SIG	604	M2	N/C	
182	SIG	545	M21	N/C	
180	SIG	544	M22	N/C	
426	SIG	605	M3	N/C	
422	SIG	603	N3	N/C	
406	SIG	599	P2	N/C	

No.	Function	Pad	Ball Function	Name	Fields
188	SIG	548	P22	N/C	
414	SIG	600	P3	N/C	
386	SIG	595	T2	N/C	
378	SIG	593	U2	N/C	
228	SIG	557	U21	N/C	
372	SIG	591	V2	N/C	
236	SIG	560	V20	N/C	
232	SIG	559	V21	N/C	
230	SIG	558	V22	N/C	
374	SIG	592	V4	N/C	
294	SIG	571	Y14	N/C	
252	SIG	562	Y18	N/C	
431	SIG	109	N1	Option	Selects the Gamma clock source: pulled down, the clock is sourced from the MClk pin. Pulled up, it is sourced from the PCI Clock
458	SIG	614	H2	PCIAD[0]	
459	SIG	116	H3	PCIAD[1]	
6	SIG	501	B6	PCIAD[10]	
8	SIG	502	D6	PCIAD[11]	
13	SIG	5	C7	PCIAD[12]	
17	SIG	6	B3	PCIAD[13]	
18	SIG	505	B8	PCIAD[14]	
25	SIG	8	B4	PCIAD[15]	Scan_In>OFLAG=BDY;KFLAG=SI
54	SIG	512	B11	PCIAD[16]	
56	SIG	513	C11	PCIAD[17]	
57	SIG	14	A8	PCIAD[18]	
62	SIG	516	B13	PCIAD[19]	
467	SIG	117	D1	PCIAD[2]	Scan_In>OFLAG=BDY;KFLAG=SI
64	SIG	517	C13	PCIAD[20]	
68	SIG	519	C14	PCIAD[21]	
70	SIG	520	D14	PCIAD[22]	
77	SIG	19	B15	PCIAD[23]	
86	SIG	523	C15	PCIAD[24]	
89	SIG	22	A19	PCIAD[25]	Scan_In>OFLAG=BDY;KFLAG=SI
90	SIG	524	B16	PCIAD[26]	

No.	Function	Pad	Ball Func- tion	Name	Fields
101	SIG	24	A20	PCIAD[27]	Scan_In>OFLAG=BDY;KFL AG=SI
102	SIG	526	B17	PCIAD[28]	
106	SIG	527	C17	PCIAD[29]	
468	SIG	616	G2	PCIAD[3]	
108	SIG	528	B18	PCIAD[30]	
110	SIG	529	C18	PCIAD[31]	
472	SIG	617	G3	PCIAD[4]	
475	SIG	119	B1	PCIAD[5]	Scan_In>OFLAG=BDY;KFL AG=SI
483	SIG	121	E2	PCIAD[6]	Scan_In>OFLAG=BDY;KFL AG=SI
484	SIG	122	D2	PCIAD[7]	Scan_In>OFLAG=BDY;KFL AG=SI
3	SIG	1	C4	PCIAD[8]	
5	SIG	3	C5	PCIAD[9]	Scan_In>OFLAG=BDY;KFL AG=SI
485	SIG	123	C2	PCICBEN[0]	Scan_In>OFLAG=BDY;KFL AG=SI
22	SIG	506	C8	PCICBEN[1]	
49	SIG	12	A5	PCICBEN[2]	
74	SIG	521	A15	PCICBEN[3]	
147	SIG	39	D22	PCIClk	Clk_input>KFLAG=+SG
38	SIG	509	B10	PCIDevselN	
46	SIG	510	C10	PCIFrameN	
148	SIG	537	J22	PCIGntN	
81	SIG	20	A16	PCIItsel	
168	SIG	540	K21	PCIIntAN	
45	SIG	11	A4	PCIIrdyN	
26	SIG	507	B9	PCIPar	
160	SIG	539	K22	PCIReqN	
167	SIG	42	D23	PCIRstN	
29	SIG	9	A3	PCIStopN	Scan_In>OFLAG=BDY;KFL AG=SI
37	SIG	10	C9	PCITRdyN	
85	WR	21	A17	N/C	
253	WR	66	AA18	N/C	
357	WR	89	AA5	N/C	
329	WR	83	AC7	N/C	
113	WR	27	C19	N/C	

No.	Function	Pad	Ball Func- tion	Name	Fields
9	WR	4	C6	N/C	
479	WR	120	E3	N/C	
451	WR	114	G1	N/C	
207	WR	52	U23	N/C	
375	WR	97	V3	N/C	
235	WR	58	W21	N/C	
73	WR2	18	A13	N/C	
21	WR2	7	A2	N/C	
105	WR2	25	A21	N/C	
109	WR2	26	A22	N/C	
53	WR2	13	A7	N/C	
61	WR2	15	A9	N/C	
227	WR2	56	AA23	N/C	
387	WR2	100	AB1	N/C	
248	WR2	64	AB19	N/C	
363	WR2	92	AB3	N/C	
313	WR2	79	AC12	N/C	
305	WR2	77	AC15	N/C	
297	WR2	75	AC17	N/C	
265	WR2	69	AC22	N/C	
349	WR2	87	AC3	N/C	
143	WR2	38	B23	N/C	
4	WR2	2	B5	N/C	
471	PWR2	118	C1	N/C	
93	WR2	23	C16	N/C	
120	WR2	31	C20	N/C	
486	WR2	124	D3	N/C	
175	WR2	44	G23	N/C	
183	WR2	46	J23	N/C	
195	WR2	49	N23	N/C	
423	WR2	107	T1	N/C	
215	WR2	54	T21	N/C	
419	WR2	106	U1	N/C	
242	WR2	62	Y21	N/C	
186	SIG	547	N21	SCIAD[0]	
190	SIG	549	P21	SCIAD[1]	
231	SIG	57	AB23	SCIAD[10]	Scan_Out>OFLAG=BDY;K FLAG=SO
247	SIG	63	AA20	SCIAD[11]	

No.	Function	Pad	Ball Func- tion	Name	Fields
249	SIG	65	AA19	SCIAD[12]	Scan_Out>OFLAG=BDY;K FLAG=SO
250	SIG	561	AB18	SCIAD[13]	
257	SIG	67	AA17	SCIAD[14]	
261	SIG	68	AB21	SCIAD[15]	Scan_Out>OFLAG=BDY;K FLAG=SO
314	SIG	580	Y10	SCIAD[16]	
317	SIG	80	AC11	SCIAD[17]	
325	SIG	82	AC8	SCIAD[18]	
333	SIG	84	AC5	SCIAD[19]	Scan_Out>OFLAG=BDY;K FLAG=SO
192	SIG	550	P20	SCIAD[2]	
336	SIG	584	AB8	SCIAD[20]	
345	SIG	86	AC4	SCIAD[21]	Scan_Out>OFLAG=BDY;K FLAG=SO
346	SIG	586	AB7	SCIAD[22]	
350	SIG	587	AA7	SCIAD[23]	
353	SIG	88	AC2	SCIAD[24]	Scan_Out>OFLAG=BDY;K FLAG=SO
360	SIG	590	Y6	SCIAD[25]	
361	SIG	90	AB5	SCIAD[26]	Scan_Out>OFLAG=BDY;K FLAG=SO
362	SIG	91	AB4	SCIAD[27]	Scan_Out>OFLAG=BDY;K FLAG=SO
369	SIG	94	Y3	SCIAD[28]	
370	SIG	95	W2	SCIAD[29]	Scan_Out>OFLAG=BDY;K FLAG=SO
196	SIG	551	R23	SCIAD[3]	
371	SIG	96	W3	SCIAD[30]	Scan_Out>OFLAG=BDY;K FLAG=SO
379	SIG	98	U3	SCIAD[31]	
199	SIG	50	R22	SCIAD[4]	
203	SIG	51	T23	SCIAD[5]	
208	SIG	553	R21	SCIAD[6]	
211	SIG	53	W23	SCIAD[7]	Scan_Out>OFLAG=BDY;K FLAG=SO
212	SIG	554	T22	SCIAD[8]	
224	SIG	556	U22	SCIAD[9]	
223	SIG	55	Y23	SCICBEN[0]	Unused_test_pad>
266	SIG	566	AA16	SCICBEN[1]	

No.	Function	Pad	Ball Function	Name	Fields
308	SIG	577	AA11	SCICBEN[2]	
352	SIG	588	AB6	SCICBEN[3]	
383	SIG	99	AA2	SCIClk	Clock_Input>KFLAG=+SG
403	SIG	103	R3	SCIClkOut[0]	
411	SIG	104	Y1	SCIClkOut[1]	
416	SIG	601	P4	SCIClkOut[2]	
420	SIG	602	N2	SCIClkOut[3]	
281	SIG	72	AA15	SCIDevselN[0]	
284	SIG	569	AB14	SCIDevselN[1]	
301	SIG	76	AC16	SCIFrameN[0]	
306	SIG	576	AB11	SCIFrameN[1]	
388	SIG	596	T3	SCIgntN	
391	SIG	101	Y2	SCIIntAN	NonTest_I/O_receiver_inhibit>KFLAG=-SG;MACRO=-TI;WRP_DC=-TI;SP_WAFER=-TI;WRP_DC_BYPASS=-TI;SP_WAFER_BYPASS=-TI
289	SIG	73	AC20	SCIIRdyN[0]	
292	SIG	570	AA14	SCIIRdyN[1]	
269	SIG	70	AB20	SCIPar	Boundary_Scan_Output_Enable>OFLAG=BDY;IOWRAP=+TI;SP_EXTIO=+TI
395	SIG	102	AA1	SCIReqN	GRA_Test_CClk2_in>KFLAG=-SC
394	SIG	597	R2	SCIRstN	
272	SIG	567	AB15	SCIStopN[0]	
273	SIG	71	AC21	SCIStopN[1]	Unused_test_pad
293	SIG	74	AC19	SCITRdyN[0]	
298	SIG	572	AB13	SCITRdyN[1]	
171	SIG	43	E23	SerialCEN	
179	SIG	45	H23	SerialData	
176	SIG	542	L22	SerialOEN	
178	SIG	543	L21	SerialWEN	
239	SIG	59	W22	TestMode	Test_Enable>KFLAG=+TI
184	SIG	546	N22	VGAEn	

### 6.1.2 Pin Listing by Ball Coordinates

No.	Function	Pad	Ball Function	Name	Fields
65	GND	16	A11	GND	
69	GND	17	A12	GND	GND>
73	WR2	18	A13	N/C	
74	SIG	521	A15	PCICBEN[3]	
81	SIG	20	A16	PCIIdsel	
85	WR	21	A17	N/C	
89	SIG	22	A19	PCIAD[25]	Scan_In>OFLAG=BDY;KFLAG=SI
21	WR2	7	A2	N/C	
101	SIG	24	A20	PCIAD[27]	Scan_In>OFLAG=BDY;KFLAG=SI
105	WR2	25	A21	N/C	
109	WR2	26	A22	N/C	
29	SIG	9	A3	PCIStopN	Scan_In>OFLAG=BDY;KFLAG=SI
45	SIG	11	A4	PCIIRdyN	
49	SIG	12	A5	PCICBEN[2]	
53	WR2	13	A7	N/C	
57	SIG	14	A8	PCIAD[18]	
61	WR2	15	A9	N/C	
395	SIG	102	AA1	SCIReqN	GRA_Test_CClk2_in>KFLAG=-SC
312	SIG	579	AA10	N/C	
308	SIG	577	AA11	SCICBEN[2]	
304	SIG	575	AA12	N/C	
300	SIG	573	AA13	N/C	
292	SIG	570	AA14	SCIIRdyN[1]	
281	SIG	72	AA15	SCIDevselN[0]	
266	SIG	566	AA16	SCICBEN[1]	
257	SIG	67	AA17	SCIAD[14]	
253	WR	66	AA18	N/C	
249	SIG	65	AA19	SCIAD[12]	Scan_Out>OFLAG=BDY;KFLAG=SO
383	SIG	99	AA2	SCIClk	Clock_Input>KFLAG=+SG
247	SIG	63	AA20	SCIAD[11]	
241	SIG	61	AA22	N/C	Unused_pin_and_test_pad>
227	WR2	56	AA23	N/C	

No.	Function	Pad	Ball Function	Name	Fields
364	SIG	93	AA4	ExtFuncEn[1]	DI2(0)_Test_I/O_drive r_inhibit>OFLAG=- BI;KFLAG=+SG
357	WR	89	AA5	N/C	
354	SIG	589	AA6	N/C	
350	SIG	587	AA7	SCIAD[23]	
337	GND	85	AA8	GND	GND>
332	SIG	583	AA9	N/C	
387	WR2	100	AB1	N/C	
310	SIG	578	AB10	N/C	
306	SIG	576	AB11	SCIFrameN[1]	
302	SIG	574	AB12	N/C	
298	SIG	572	AB13	SCITRdyN[1]	
284	SIG	569	AB14	SCIDevselN[1]	
272	SIG	567	AB15	SCIStopN[0]	
264	SIG	565	AB16	N/C	
256	SIG	563	AB17	N/C	
250	SIG	561	AB18	SCIAD[13]	
248	WR2	64	AB19	N/C	
269	SIG	70	AB20	SCIPar	Boundary_Scan_Output _Enable>OFLAG=BD Y;IOWRAP=+TI;SP_E XTIO=+TI
261	SIG	68	AB21	SCIAD[15]	Scan_Out>OFLAG=B DY;KFLAG=SO
231	SIG	57	AB23	SCIAD[10]	Scan_Out>OFLAG=B DY;KFLAG=SO
363	WR2	92	AB3	N/C	
362	SIG	91	AB4	SCIAD[27]	Scan_Out>OFLAG=B DY;KFLAG=SO
361	SIG	90	AB5	SCIAD[26]	Scan_Out>OFLAG=B DY;KFLAG=SO
352	SIG	588	AB6	SCICBEN[3]	
346	SIG	586	AB7	SCIAD[22]	
336	SIG	584	AB8	SCIAD[20]	
321	GND	81	AB9	GND	GND>
317	SIG	80	AC11	SCIAD[17]	
313	WR2	79	AC12	N/C	
309	GND	78	AC13	GND	GND>
305	WR2	77	AC15	N/C	



No.	Function	Pad	Ball Function	Name	Fields
301	SIG	76	AC16	SCIFrameN[0]	
297	WR2	75	AC17	N/C	
293	SIG	74	AC19	SCITRdyN[0]	
353	SIG	88	AC2	SCIAD[24]	Scan_Out>OFLAG=BDY;KFLAG=SO
289	SIG	73	AC20	SCIIRdyN[0]	
273	SIG	71	AC21	SCIStopN[1]	Unused_test_pad
265	WR2	69	AC22	N/C	
349	WR2	87	AC3	N/C	
345	SIG	86	AC4	SCIAD[21]	Scan_Out>OFLAG=BDY;KFLAG=SO
333	SIG	84	AC5	SCIAD[19]	Scan_Out>OFLAG=BDY;KFLAG=SO
329	WR	83	AC7	N/C	
325	SIG	82	AC8	SCIAD[18]	
320	SIG	581	AC9	N/C	
475	SIG	119	B1	PCIAD[5]	Scan_In>OFLAG=BDY;KFLAG=SI
38	SIG	509	B10	PCIDevselN	
54	SIG	512	B11	PCIAD[16]	
58	SIG	514	B12	N/C	
62	SIG	516	B13	PCIAD[19]	
66	SIG	518	B14	N/C	
77	SIG	19	B15	PCIAD[23]	
90	SIG	524	B16	PCIAD[26]	
102	SIG	526	B17	PCIAD[28]	
108	SIG	528	B18	PCIAD[30]	
117	SIG	28	B19	AGPSBA[7]	Test_CClk_in>KFLAG=-SC
118	SIG	29	B20	AGPSBA[6]	Test_BClk_in>KFLAG=-BC
119	SIG	30	B21	AGPSBA[5]	Test_AClk_in>KFLAG=-AC
143	WR2	38	B23	N/C	
17	SIG	6	B3	PCIAD[13]	
25	SIG	8	B4	PCIAD[15]	Scan_In>OFLAG=BDY;KFLAG=SI
4	WR2	2	B5	N/C	
6	Sig	501	B6	PCIAD[10]	
10	SIG	503	B7	N/C	

No.	Function	Pad	Ball Function	Name	Fields
18	SIG	505	B8	PCIAD[14]	
26	SIG	507	B9	PCIPar	
471	PWR2	118	C1	N/C	
46	SIG	510	C10	PCIFrameN	
56	SIG	513	C11	PCIAD[17]	
60	SIG	515	C12	N/C	
64	SIG	517	C13	PCIAD[20]	
68	SIG	519	C14	PCIAD[21]	
86	SIG	523	C15	PCIAD[24]	
93	WR2	23	C16	N/C	
106	SIG	527	C17	PCIAD[29]	
110	SIG	529	C18	PCIAD[31]	
113	WR	27	C19	N/C	
485	SIG	123	C2	PCICBEN[0]	Scan_In>OFLAG=BDY;KFLAG=SI
120	WR2	31	C20	N/C	
139	SIG	37	C22	AGPSBA_ModeCtl[0]	Boundary_Scan_Enable>KFLAG=+SG
151	SIG	40	C23	AGPSt[1]	Unused_test_pad>
3	Sig	1	C4	PCIAD[8]	
5	Sig	3	C5	PCIAD[9]	Scan_In>OFLAG=BDY;KFLAG=SI
9	WR	4	C6	N/C	
13	SIG	5	C7	PCIAD[12]	
22	SIG	506	C8	PCICBEN[1]	
37	SIG	10	C9	PCITRdyN	
467	SIG	117	D1	PCIAD[2]	Scan_In>OFLAG=BDY;KFLAG=SI
50	SIG	511	D10	N/C	
70	SIG	520	D14	PCIAD[22]	
114	SIG	530	D18	N/C	
484	SIG	122	D2	PCIAD[7]	Scan_In>OFLAG=BDY;KFLAG=SI
125	SIG	32	D21	N/C	
147	SIG	39	D22	PCIClk	Clk_input>KFLAG=+SG
167	SIG	42	D23	PCIRstN	
486	WR2	124	D3	N/C	
8	SIG	502	D6	PCIAD[11]	

No.	Function	Pad	Ball Function	Name	Fields
455	SIG	115	E1	MClk	Clock_input>KFLAG=+SG
483	SIG	121	E2	PCIAD[6]	Scan_In>OFLAG=BDY;KFLAG=SI
127	SIG	34	E21	AGPSBA[3]	GRA_Scan_Bypass>OFLAG=BDY;KFLAG=-SG;SP_WAFER_BYPASS=+TI;WRP_DC_BYPASS=+TI
126	SIG	33	E22	AGPSBA[4]	
171	SIG	43	E23	SerialCEN	
479	WR	120	E3	N/C	
474	SIG	618	F2	N/C	
130	SIG	532	F20	N/C	
131	SIG	35	F21	AGPSBA_ModeCtl[1]	
128	SIG	531	F22	AGPSBA[2]	
476	SIG	619	F3	N/C	
482	SIG	620	F4	N/C	
451	WR	114	G1	N/C	
468	SIG	616	G2	PCIAD[3]	
135	SIG	36	G21	AGPRbfN	
132	SIG	533	G22	N/C	
175	WR2	44	G23	N/C	
472	SIG	617	G3	PCIAD[4]	
447	SIG	113	H1	GLINTOutDis[0]	
458	SIG	614	H2	PCIAD[0]	
144	SIG	536	H21	AGPSt[2]	
140	SIG	535	H22	AGPPipeN	
179	SIG	45	H23	SerialData	
459	SIG	116	H3	PCIAD[1]	
442	SIG	611	J1	N/C	
443	SIG	112	J2	GLINTOutDis[1]	
159	SIG	41	J21	AGPSt[0]	
148	SIG	537	J22	PCIGntN	
183	WR2	46	J23	N/C	
454	SIG	613	J3	N/C	
432	SIG	608	K2	N/C	
172	SIG	541	K20	N/C	

No.	Function	Pad	Ball Function	Name	Fields
168	SIG	540	K21	PCIIntAN	
160	SIG	539	K22	PCIReqN	
434	SIG	609	K3	N/C	
436	SIG	610	K4	N/C	
439	SIG	111	L1	GLINTInDis[1]	
428	SIG	606	L2	N/C	
178	SIG	543	L21	SerialWEN	
176	SIG	542	L22	SerialOEN	
187	GND	47	L23	GND	GND>
430	SIG	607	L3	N/C	
435	GND	110	M1	GND	GND>
424	SIG	604	M2	N/C	
182	SIG	545	M21	N/C	
180	SIG	544	M22	N/C	
191	GND	48	M23	GND	GND>
426	SIG	605	M3	N/C	
431	SIG	109	N1	Option	Selects the Gamma clock source: pulled down, the clock is sourced from the MClk pin. Pulled up, it is sourced from the PCI Clock
420	SIG	602	N2	SCIClkOut[3]	
186	SIG	547	N21	SCIAD[0]	
184	SIG	546	N22	VGAEn	
195	WR2	49	N23	N/C	
422	SIG	603	N3	N/C	
406	SIG	599	P2	N/C	
192	SIG	550	P20	SCIAD[2]	
190	SIG	549	P21	SCIAD[1]	
188	SIG	548	P22	N/C	
414	SIG	600	P3	N/C	
416	SIG	601	P4	SCIClkOut[2]	
427	SIG	108	R1	GLINTInDis[0]	
394	SIG	597	R2	SCIRstN	
208	SIG	553	R21	SCIAD[6]	
199	SIG	50	R22	SCIAD[4]	
196	SIG	551	R23	SCIAD[3]	
403	SIG	103	R3	SCIClkOut[0]	
423	WR2	107	T1	N/C	

No.	Function	Pad	Ball Function	Name	Fields
386	SIG	595	T2	N/C	
215	WR2	54	T21	N/C	
212	SIG	554	T22	SCIAD[8]	
203	SIG	51	T23	SCIAD[5]	
388	SIG	596	T3	SCIGntN	
419	WR2	106	U1	N/C	
378	SIG	593	U2	N/C	
228	SIG	557	U21	N/C	
224	SIG	556	U22	SCIAD[9]	
207	WR	52	U23	N/C	
379	SIG	98	U3	SCIAD[31]	
372	SIG	591	V2	N/C	
236	SIG	560	V20	N/C	
232	SIG	559	V21	N/C	
230	SIG	558	V22	N/C	
375	WR	97	V3	N/C	
374	SIG	592	V4	N/C	
415	GND	105	W1	GND	GND>
370	SIG	95	W2	SCIAD[29]	Scan_Out>OFLAG=BDY;KFLAG=SO
235	WR	58	W21	N/C	
239	SIG	59	W22	TestMode	Test_Enable>KFLAG=+TI
211	SIG	53	W23	SCIAD[7]	Scan_Out>OFLAG=BDY;KFLAG=SO
371	SIG	96	W3	SCIAD[30]	Scan_Out>OFLAG=BDY;KFLAG=SO
411	SIG	104	Y1	SCIClkOut[1]	
314	SIG	580	Y10	SCIAD[16]	
294	SIG	571	Y14	N/C	
252	SIG	562	Y18	N/C	
391	SIG	101	Y2	SCIIntAN	NonTest_I/O_receiver_inhibit>KFLAG=-SG;MACRO=-TI;WRP_DC=-TI;SP_WAFER=-TI;WRP_DC_BYPASS=-TI;SP_WAFER_BYPASS=-TI

No.	Function	Pad	Ball Func- tion	Name	Fields
242	WR2	62	Y21	N/C	
240	SIG	60	Y22	ExtFuncEn[0]	DI1(0)_NonTest_I/O_ driver_inhibit>OFLAG =-BI;KFLAG=- OI;MACRO=- TI;WRP_DC=- TI;SP_WAFER=- TI;WRP_DC_BYPASS =- TI;SP_WAFER_BYPA SS=-TI
223	SIG	55	Y23	SCICBEN[0]	Unused_test_pad>
369	SIG	94	Y3	SCIAD[28]	
360	SIG	590	Y6	SCIAD[25]	

# 7

## Package Dimensions

The package is a super BGA (SBGA) 304 ball configuration. The bottom view is shown below. The chamfered edge corresponds to the A1 ball location.

Figure 7-1 Package Diagram (Bottom View)

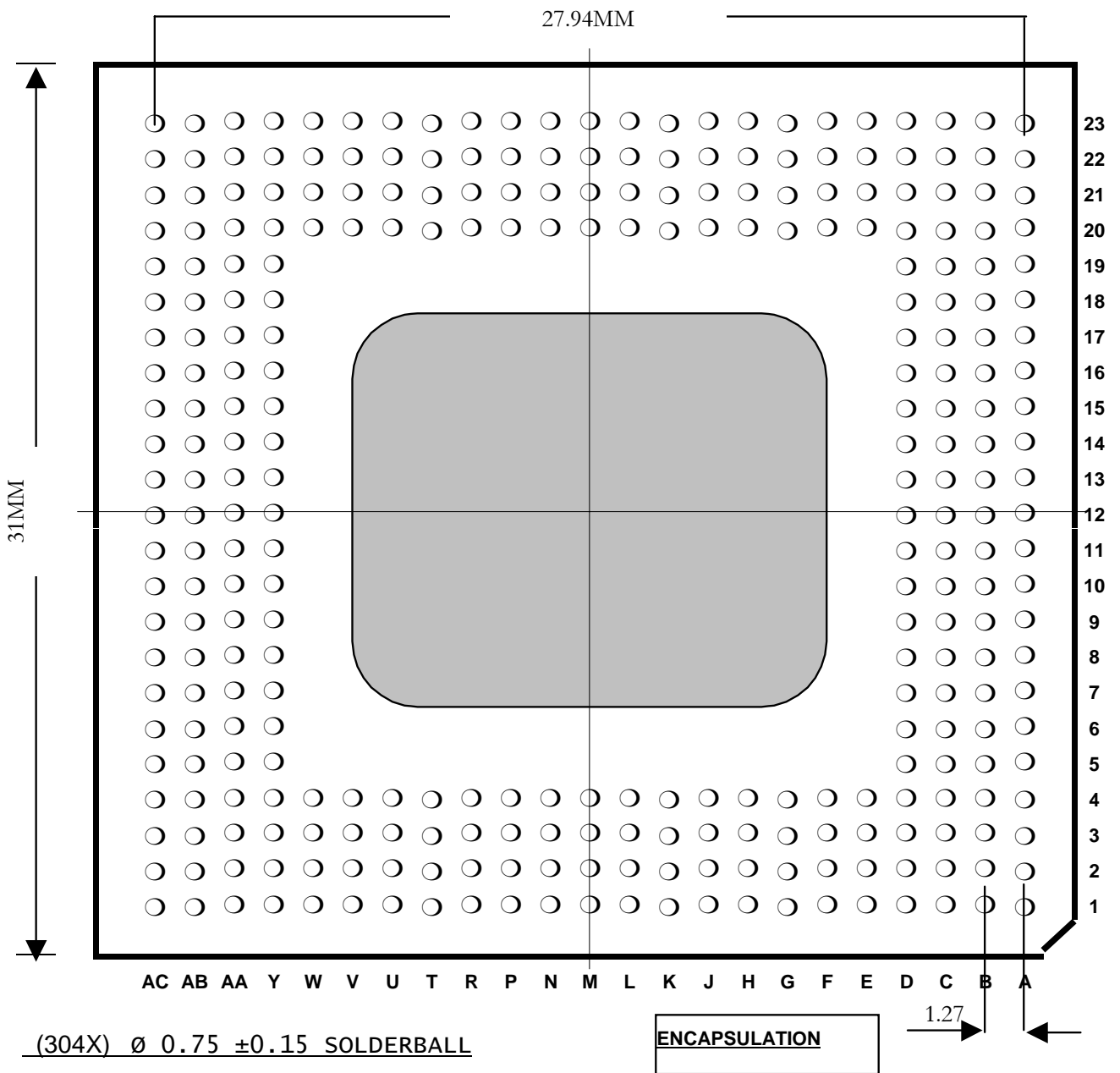

**Figure 7-2 Package Diagram (Top View)**

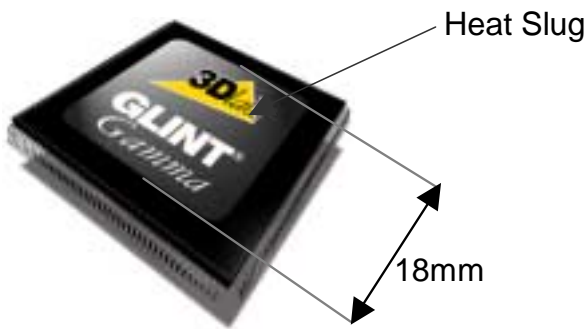

**Figure 7-3 Gamma2 Mechanical Dimensions**

Dimension	mm
Lead Pitch	1.27
Height (Max)	2.65
Ball height	0.60 ± 0.1
Body Width	31
Encapsulation width	18

**Table 7-4 304 pin SBGA Package Dimensions**



---

---

# 8

---

---

## Gamma System Design

---

---

The following notes should be followed when designing systems which use the Gamma device.

### 8.1 Termination / Pull-ups

The signals SCIFrameN(0:1), SCIRdyN(0:1), SCITRdyN(0:1), SCIStopN(0:1), SCIDevselN(0:1) are Tri-state signals which need to be held in their inactive state by 10K Ohm pull-up resistors.

SCIIntAN is an open drain signal which should all be pulled high with a 10K Ohm resistor.

The Testmode pin should be pulled low. Typically a 470 Ohm resistor would be used.

### 8.2 Secondary device IDSel wiring

Each secondary PCI device has an IDSel pin which must be wired up to allow Configuration space accesses to occur. On Gamma the IDSel lines are multiplexed onto the SCIAD bus. The IDSels should be wired as follows:

- SCIAD28 should be connected to Idsel of a device fitted as secondary device 1.
- SCIAD29 should be connected to Idsel of a device fitted as secondary device 2.
- SCIAD30 should be connected to Idsel of a device fitted as secondary device 3.

### 8.3 GLINT side-band signals

GLINT devices have 2 sets of side-band signals for use after a Gamma device. These control data throttling into the input FIFO, and out of the output FIFO.

- The Gamma GLINTInDis0 should be connected to PCIFIFOInDis of the GLINT rendering device fitted as secondary device 1.
- The Gamma GLINTOutDis0 should be connected to PCIFIFOOutDis of the GLINT rendering device fitted as secondary device 1.
- The Gamma GLINTInDis1 should be connected to PCIFIFOInDis of a GLINT rendering device fitted as secondary device 2.
- The Gamma GLINTOutDis1 should be connected to PCIFIFOOutDis of the GLINT rendering device fitted as secondary device 2.

### 8.4 Using a secondary bus master

The Gamma device allows for one device to be a PCI bus master. To use PCI bus mastering the device must be connected to the second set of secondary bus PCI control signals. i.e. SCIFrameN(1), SCIRdyN(1), SCITRdyN(1), SCIStopN(1), and SCIDevselN(1).

# 9

## Thermal Characteristics

The maximum junction temperature must be kept below  $T_j(\text{max})$  and this can only be guaranteed by proper analysis of the operating environment and the thermal path between the die and the air surrounding it.

### 9.1 Device Characteristics

These are fixed characteristics of the device and are independent of the operating environment or the characteristics of any heatsink:-

$$T_{j(\text{max})} = 100 \text{ }^\circ\text{C}.$$

$$P_{d(\text{max})} = 6.5 \text{ Watts @ } V_{dd(\text{max})}, f_{MClk} = 125\text{MHz}, f_{IOClk} = 66\text{MHz}.$$

$$\theta_{jt} = 1.1 \text{ }^\circ\text{C/Watt}.$$

### 9.2 Thermal Model

The formula used to calculate the junction temperature ( $T_j$ ) is

$$\begin{aligned} T_j &= T_a + P_d(\theta_{jt} + \theta_{cs} + \theta_{sa}) \\ &= T_a + P_d\theta_{ja} \end{aligned}$$

Where:

$$T_j = \text{Junction temperature (}^\circ\text{C)}$$

$$T_a = \text{Ambient temperature (}^\circ\text{C)}$$

$$P_d = \text{Power dissipation (Watts)}$$

$$\theta_{jt} = \text{Junction to top of case thermal resistance (}^\circ\text{C/Watt)}$$

$$\theta_{cs} = \text{Case to Heatsink thermal resistance (}^\circ\text{C/Watt)}$$

$$\theta_{sa} = \text{Heatsink to Air thermal resistance (}^\circ\text{C/Watt)}$$

$$\theta_{ja} = \text{Total Junction to Air thermal resistance (}^\circ\text{C/Watt)}$$

The  $\theta_{ja}$  form of the equation is more appropriate when there is no heatsink attached to the device.

### 9.3 Operation Without Heatsink

Gamma should not be operated without a heatsink attached.

### 9.4 Operation With Heatsink

With a heatsink attached to the device the junction temperature will depend on  $\theta_{CS}$  and  $\theta_{SA}$ .  $\theta_{CS}$  is the thermal resistance of the join between the heatsink and the case.  $\theta_{SA}$  is the thermal resistance of the heatsink and will be a function of system airflow.

The table below shows the calculated thermal figures for a 27mmx27mm heatsink with 11.4mm high fins.

Airflow lfpm	$\theta_{ja}$ ° C/W
0 (Convection Cooling)	9.2
50 (0.25m/sec)	8.1
100 (0.5m/sec)	6.7
200 (1.0m/sec)	Not calculated
400 (2.0m/sec)	Not calculated

**Table 9-1 Operation With Heatsink**

This heatsink would be suitable for Gamma operation for ambient temperatures of up to 35°C with zero airflow.

#### 9.4.1 Heatsink Attachment

The following method has been approved for the purpose of attaching a heatsink directly onto the copper surface of the SBGA package:

Thermally conductive epoxy using either Loctite Output 315 with Loctite 7386 or type EG 7655 from A.I. Technology Inc. The thickness of the epoxy layer should be between 0.05mm and 0.15mm with 95% coverage of the contact area.

Typical achievable  $\theta_{CS}$  using this method is 1.0 ° C/Watt

# 10

## Index

AC Specifications	62	Multi-function indication	11
AGP		PCI	11
Registers	26	multi-function support	
Alphabetical Pin Listing	82	Gamma	11
Base Addresses	30	Multi-GLINT aperture	14
Characteristics		Next Ptr	26
Device	86	OpenGL	5
Thermal	86	Package Diagram (Bottom View)	83
Clock Timing	63	Package Diagram (Top View)	84
<b>Command Register</b>	19	<b>Page Table Length Register</b>	48
Configuration Registers	15	PCI 66MHz capable	11
Control Status Registers	34	PCI Address Regions	11
DC Specifications	61	PCI Configuration Region	15
Delta	8	PCI Configuration Space	12
Device Control	19	Pin Information	67
Device Status	20	Pull-ups	85
DMA Start Address	37	Region 0 access	29
EEPROM	7, 9	Region 0 Address Map	34
Electrical Data	61	Reset Status Register	37
Gamma Control Registers	12	secondary bus master	85
Gamma Functions	31	Secondary device IDSel wiring	85
<b>Gamma Processor Mode Register</b>	54	Serial configuration mode	9
Graphics Core FIFO Interface	59	Serial EEPROM Access	28
Graphics Core Registers	59	side-band signals	85
Heatsink	86, 87	<b>Status Register</b>	20
Attachment	87	Termination	85
Preferred Attachment Method	87	Thermal	
Input / Output Timing	64	Model86	
Input FIFO Space Register	37	VGA Aliasing	13
Internal Function	15	VGA register shadowing	13
Introduction	5	VGA Shadow Control Register	54
Legacy Class Codes	11	VGA Support	12
MClk	86	Xicor	9
Miscellaneous Functions	21		